

14-470 Removal, reinstallation of exhaust manifold

A. Model 107

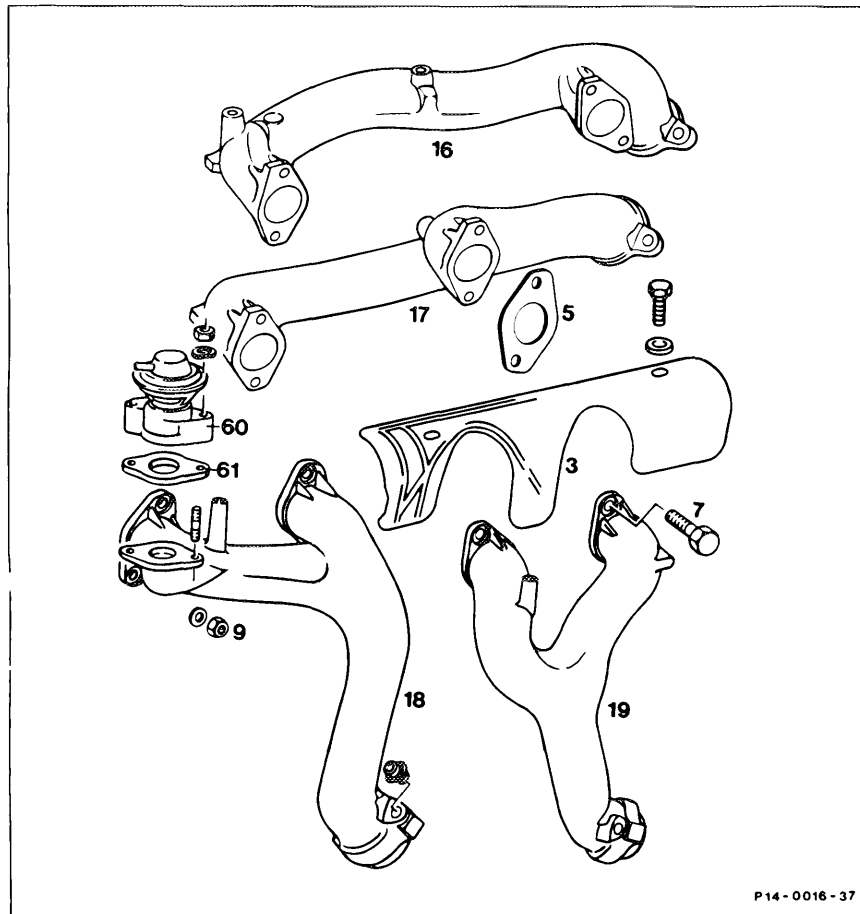

P14-0016-37

- Exhaust system remove, reinstall (49-100).
- Air cleaner remove, reinstall (09-400).
- Spark plug connector remove, refit.

Exhaust manifold left

- Exhaust gas recirculation valve (60) remove, reinstall. Use new gasket (61) during installation.
- Shield (3) remove, reinstall.

Engine mounts	loosen, tighten with 75 Nm.
Engine shock absorber	with bracket, remove, reinstall.
Engine	lift with pit lift.
Exhaust manifold	remove, reinstall. Unscrew screws (7) and nuts (9). Install with new nuts (9) and gaskets (5). Gaskets with metal side facing cylinder head (see Note).
High-pressure hose for power steering	from power steering and bracket on wheel arch, disconnect, reconnect.

Exhaust manifold right

Coolant expansion tank	remove, reinstall.
Shield (3)	remove, reinstall.
Exhaust manifold	remove, reinstall. Unscrew screws (7) and nuts (9). Install with new nuts (9) and gaskets (5) with metal side facing cylinder head (see Note).
Exhaust system	check for leaks by running engine.

Note
Install gaskets with the metal side facing the cylinder head.

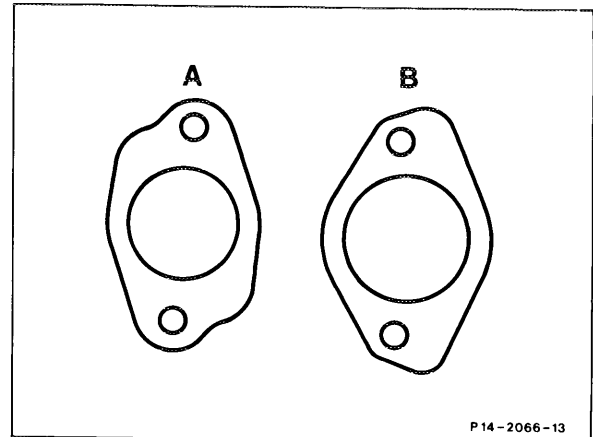

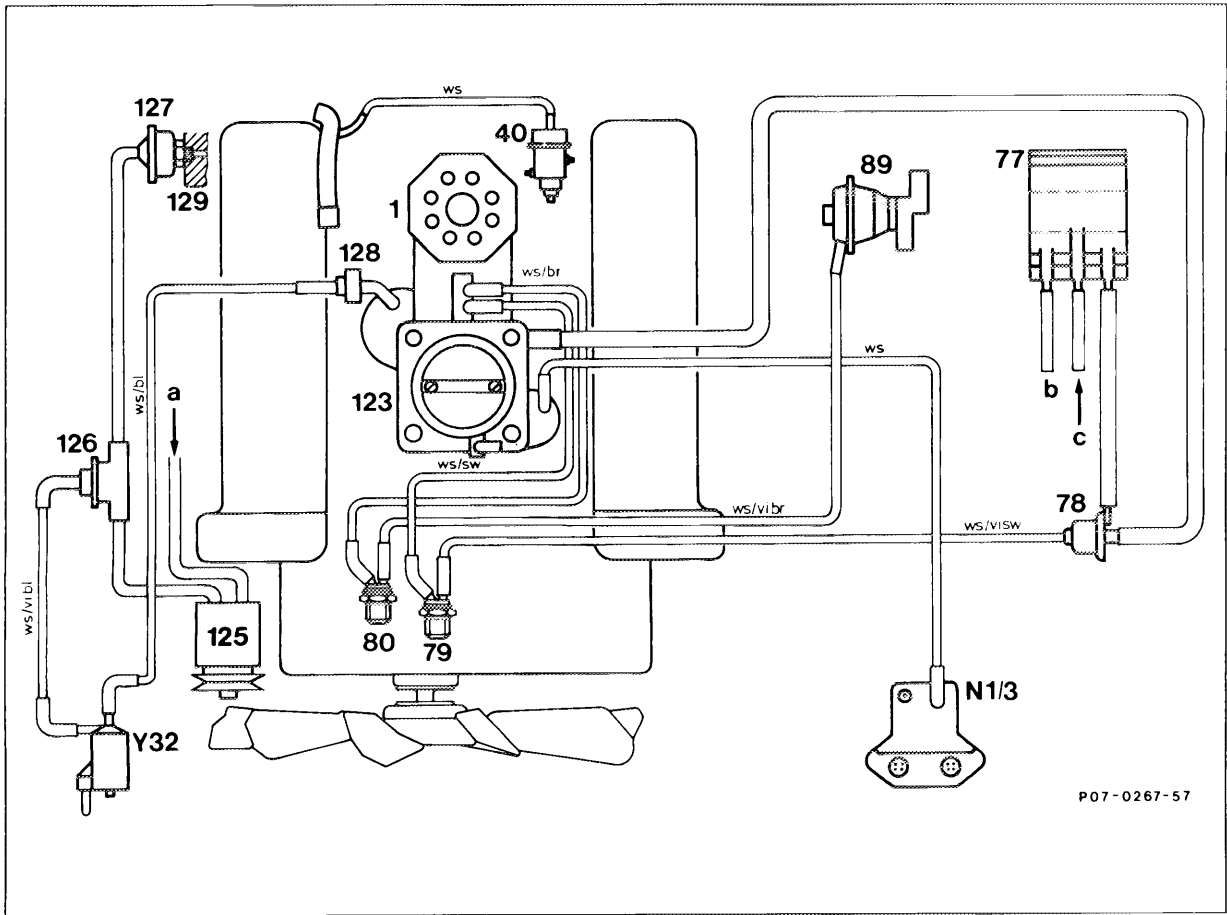

Function diagram air injection and exhaust gas recirculation starting 09/87

N1/2	Control unit ignition system (EZL)	79	Therموvalve 70° C
Y32	Change-over valve air pump	80	Therموvalve 50° C
a	from air cleaner	89	Exhaust gas recirculating valve
b	to fuel tank	123	Throttle assembly
c	Ventilation	125	Air pump
1	Mixture control unit	126	Air shut-off valve
40	Diaphragm pressure regulator	127	Check valve (injection air)
77	Charcoal canister	128	Check valve (vacuum)
78	Purge valve	129	Timing case cover

C. CIS-E control unit (N3)

On model 107 the CIS-E control unit is installed in the footwell right below the floor plate and in model 126, in the footwell right behind the lateral covering.



With ignition switched on or engine running, **do not pull** coupling off CIS-E control unit as the CIS-E control unit could be damaged due to voltage or current peaks.

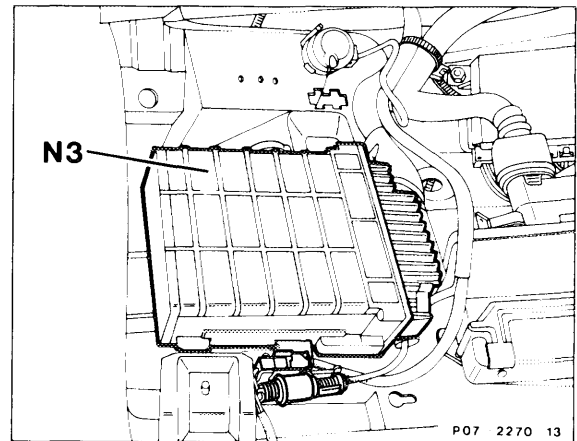

Model 107

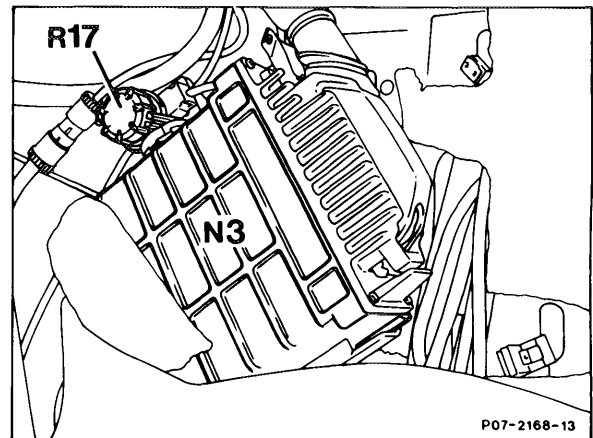

Model 126 (R17 not used)

With the ignition switched on, a certain current is available on the electrohydraulic adjusting element while a certain impulse period is output at the lambda measuring output (see 07.3-121). The CIS-E control unit has two injection programs (with/without lambda control). The respective program is activated by means of the reference resistor.

B. Model 126

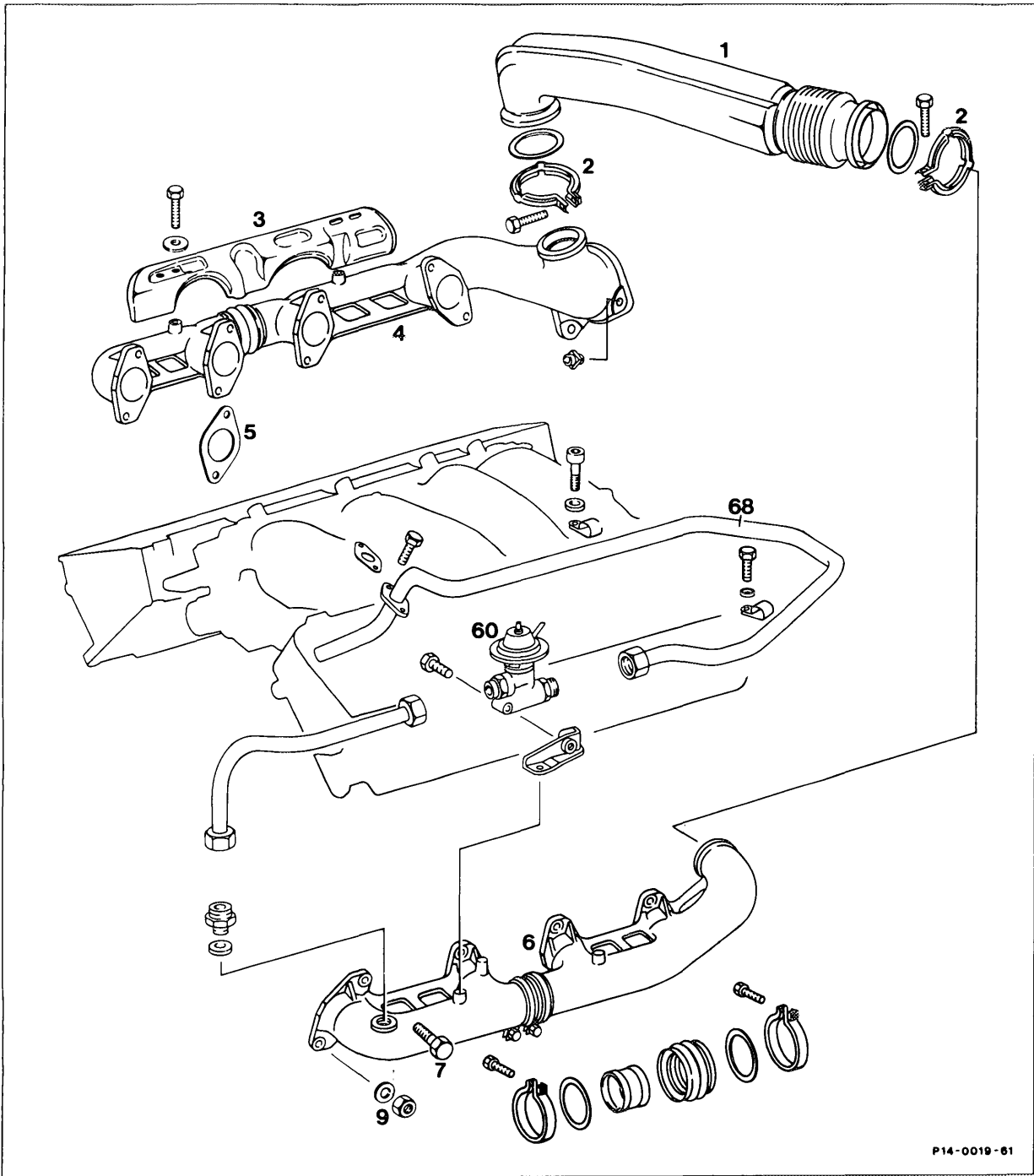

Spark plug connector remove, refit.

Exhaust manifold left

- Mounting clamp (2) on transverse pipe (1) unscrew, screw on.
- Shield (3) remove, reinstall.
- Exhaust gas recirculation line (68) disconnect from exhaust gas recirculation valve (60), reconnect.
- Exhaust manifold (6) remove, reinstall. Unscrew screws (7) and nuts (9). Install with new nuts (9) and gaskets (5). Gaskets with metal side facing the cylinder head (see Note).

Exhaust manifold right

- Exhaust system remove, reinstall (49-100).
- Mounting clamp (2) for transverse pipe (1) unscrew, screw on.
- Air cleaner remove, reinstall (09-400).
- Shield (3) remove, reinstall.
- Exhaust nuts (9) and bolts (7) remove, reinstall.
- Exhaust manifold (4) remove from below. Mount with new nuts (9) and gaskets (5). Metal side facing cylinder head (see Note). Before tightening the nuts and bolts, flange on transverse pipe.
- Exhaust system check for leaks by running engine.

Note

Install gaskets with the metal side facing the cylinder head.
 Observe difference between engines 116 and 117.

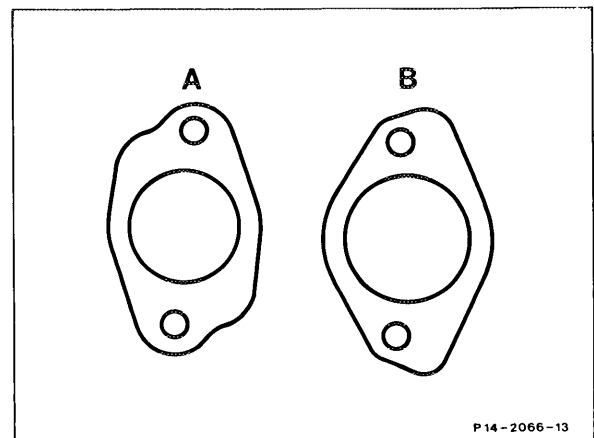

A Engine 116
 B Engine 117

P14 - 2066 - 13