

Oil circuit with air-oil cooler

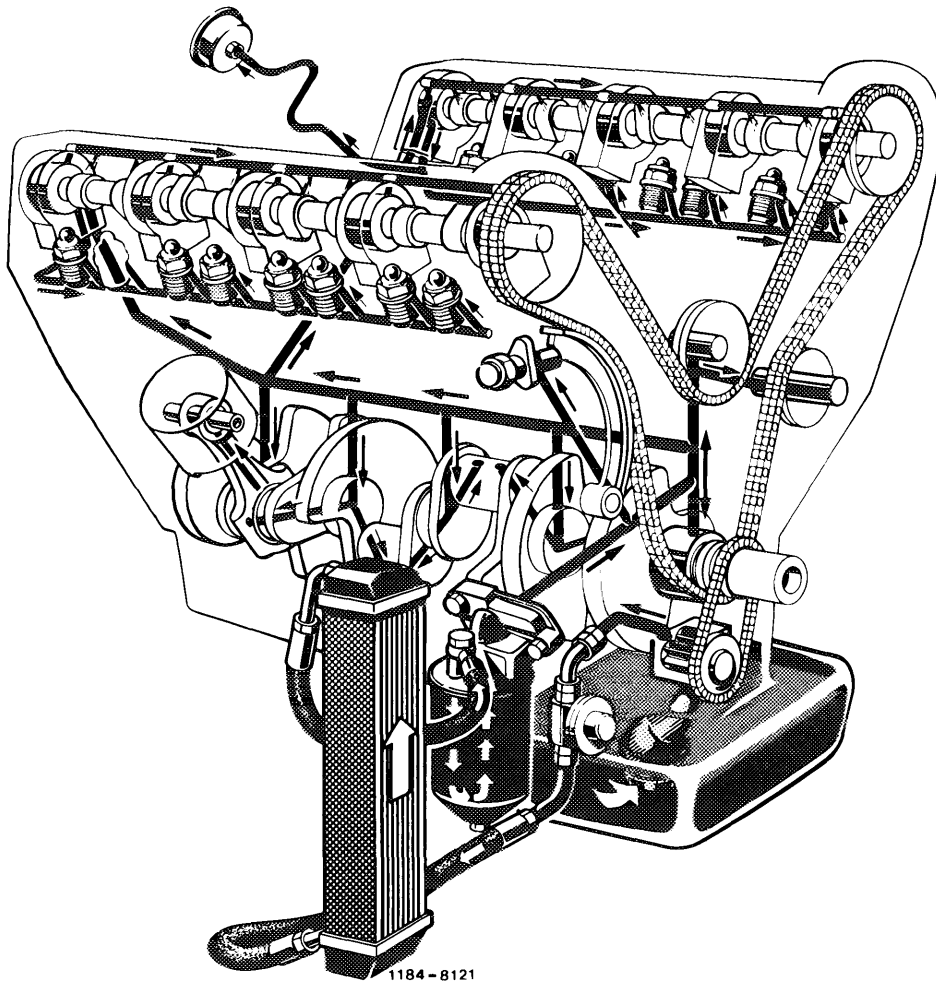

Oil pressure

At operating temperature, the oil pressure at idle speed may drop to 0.3 bar gauge pressure.

During acceleration, the oil pressure should immediately rise again and attain at least 3 bar gauge pressure at 3000/min.

Pressure relief and bypass valves, oil filter

Opening pressure of pressure relief valves	bar gauge pressure
Pressure relief valve (15) in main oil duct	5
Bypass valve (16) air-oil cooler	1.5
Bypass valve (20) filter element	4.5

The **oil pressure relief valve (15)** at crankcase face end in main oil duct behind oil filter **limits the oil pressure to 5 bar gauge pressure (5 atü)**. The overflowing oil returns to the oil pan. This valve is accessible upon opening of a closing plug in timing housing cover.

The pressure relief valve itself cannot be disassembled.

- 15 Oil pressure relief valve 5 bar gauge pressure
- 16 Bypass valve oil cooler 1.5 bar gauge pressure

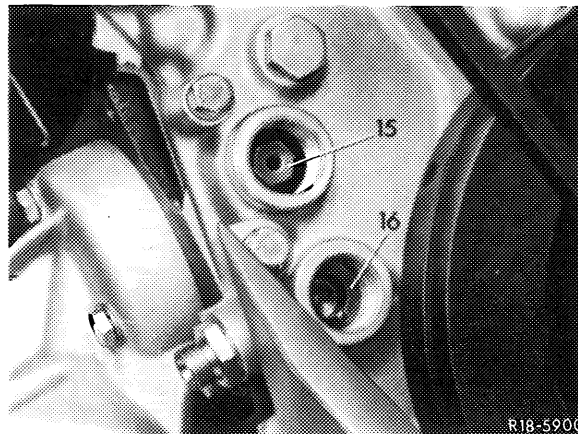

Bypass valve air-oil cooler

- 16 Valve seat ring
- 17 Valve cone
- 18 Compression spring
- 19 Valve guide

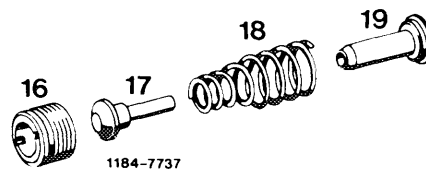

The **bypass valve (16)** for the air-oil cooler with an opening pressure of 1.5 bar gauge pressure on crankcase face end is concealed by a closing plug in timing housing cover. This valve opens when the flow resistance of the cold oil in oil cooler is high.

Note: To remove bypass valve (16), the vibration damper on vehicles with closing plug in forward position must be taken off (03-340).

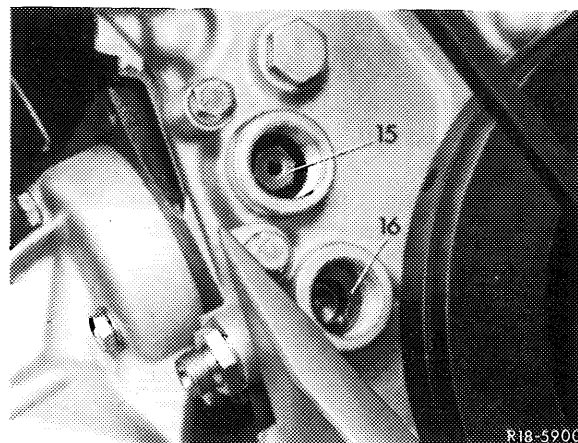

The **bypass valve (20)** for filter element is located in crankcase and enters the oil main duct. When the difference pressure between oil filter at dirt end and oil main duct exceeds 4.5 bar gauge pressure, that is, when e.g. the filter element is badly contaminated, this valve will open and the oil will flow to bearing points in uncleaned condition.

Engine 116.982/992/983/993/984/985
117.982/992/983/993/985/986

- 20 Bypass valve filter element
- A Oil inlet unfiltered
- B Oil outlet filtered

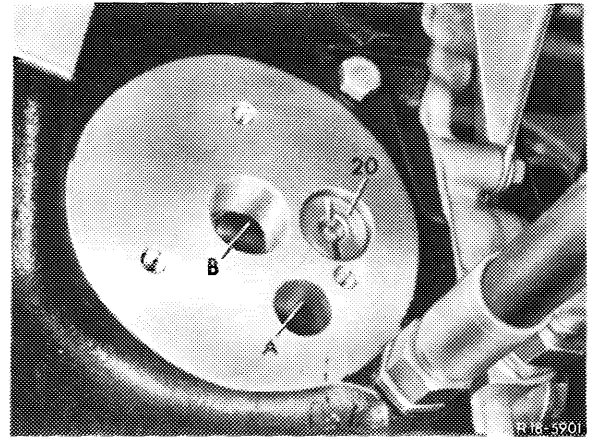

- 20 Bypass valve filter element
- 21 Valve
- 22 Compression spring
- 23 Locking ring

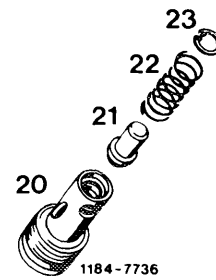

Engine 116.980/990/981/991
117.981/984

- 7 Connection
- 20 Bypass valve filter element
- A Oil inlet unfiltered
- B Oil outlet filtered
- C Connection lube oil line — air compressor (type 109 only)

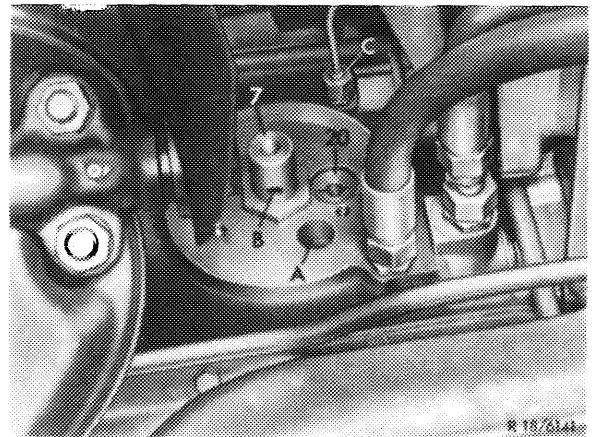

Oil filter

- 1 Center bolt
- 2 Sealing ring
- 3 Oil filter housing
- 4 O-ring
- 5 Compression spring with spring retainer
- 6 Paper filter element
- 7 Connection
- 8 Intermediate flange (types 107, 116)
- 9 Gasket
- 10 3 spring washers
- 11 3 screws M 8 x 45

