





## 13-340 Replacing and tensioning V-belts

V-belt		A	B				C					D		E	
Dimensions		Air compressor 9,5 X 838 (air suspension)	Coolant pump – power steering pump				Alternator					Refrigerant compressor		Air pump	
		9,5 X 1160	9,5 X 1184	9,5 X 1200	9,5 X 1225	9,5 X 913	9,5 X 950	9,5 X 980	9,5 X 1000	9,5 X 1025	12,5 X 850	12,5 X 825	9,5 X 935	9,5 X 875	
Installed in		Double V-belts may be replaced in sets only				USA and California 1974					1974 Cali- for- nia		    12)		
Type	Engine														
107.023/043	116.982/929		X	X <sup>9)</sup>		X <sup>7)</sup>	X				X				
	116.984			X		X					X	X <sup>13)</sup>			
107.024/044	117.982/992		X <sup>2)</sup>	X <sup>1)</sup>	X <sup>9)</sup>			<sup>7)10)</sup> X	X	X <sup>8)</sup>	X		X	X	
	117.985				X				X		X <sup>11)</sup>	X		X	
108.057/058	116.980/990			X <sup>4)</sup>		X <sup>3)</sup>	X				X				
108.067/068	117.984		X						X		X				
109.056	116.981/991	X		X <sup>6)</sup>		X <sup>5)</sup>	X				X				
109.057	117.981	X	X						X		X				
111.026/027	116.980					X	X				X				
116.028/029	116.983/993			X	X <sup>9)</sup>		X <sup>7)</sup>	X			X				
	116.985				X		X				X	X <sup>14)</sup>			
116.023/033	117.983/993		X		X <sup>9)</sup>			<sup>7)10)</sup> X	X	X <sup>8)</sup>	X		X	X	
	117.986				X				X		X <sup>11)</sup>	X		X	

1) Up to chassis end No. 002614.

2) Starting chassis end No. 002615.

3) Up to chassis end No. 003369.

4) Starting chassis end No. 003370.

5) Up to chassis end No. 007234.

6) Starting chassis end No. 007235.

7) Starting alternator mounting bracket with toothed disc adjust with toothed disc adjustment.

8) Type 107.024 starting chassis end No. 007725 up to chassis end No. 008175.  
Type 107.044 starting chassis end No. 020995 up to chassis end No. 021704.  
Type 116.032/033 starting chassis end No. 028710 up to chassis end No. 029558.

9) Starting power steering pump 2nd version (VT 49).





10) In vehicles with the following chassis numbers, V-belt 9.5 x 1000 has been installed:  
Type 107.024 starting chassis end No. 008589 up to chassis end No. 009425,

107.044 starting chassis end No. 022627

up to chassis end No. 024745,

116.032/033 starting chassis end No.

032886 up to chassis end No. 036799.

11)  starting 1976 (with pulley 148 mm OD on crankshaft) and    starting 1977.

12)  starting 1977.

 starting 1976.

 starting 1976.

 1975 and 1976

 1977 California only.

13) Type 107.023 starting chassis end No. 011722,  
107.043 starting chassis end No. 012964.

14) Starting chassis end No. 040535.

Engine 116.980/984  
 116.982/992  
 116.983/993  
 116.984  
 116.985  
 117.982/992  
 117.983/993  
 117.984  
 117.985  
 117.986

- 1 Crankshaft
- 2 Coolant pump
- 3 Alternator
- 4 Refrigerant compressor
- 5 Tensioning roller
- 6 Power steering pump

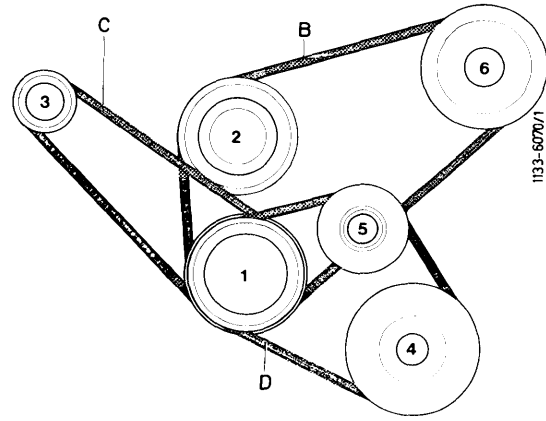

Engine 116.981/991  
 117.981

- 1 Crankshaft
- 2 Coolant pump
- 3 Alternator
- 4 Refrigerant compressor
- 5 Tensioning roller
- 6 Power steering pump
- 9 Air compressor – air suspension

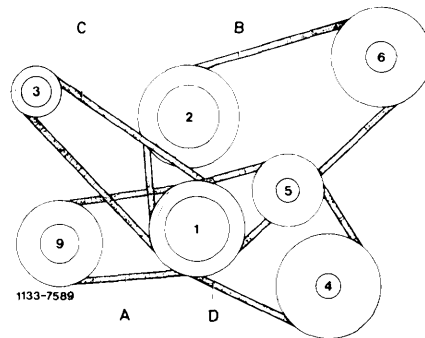

(USA) 1974 California

- 1 Crankshaft
- 2 Coolant pump
- 3 Alternator
- 4 Refrigerant compressor
- 5 Tensioning roller
- 6 Power steering pump
- 7 Air pump

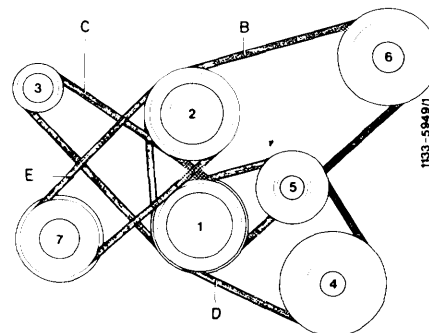

- (USA) starting 1977
- (J) starting 1976
- (S) starting 1976
- (USA) 1975 and 1976
- (USA) 1977 California only

- 1 Crankshaft
- 2 Coolant pump
- 3 Alternator
- 4 Refrigerant compressor
- 5 Tensioning roller
- 6 Power steering pump
- 7 Air pump

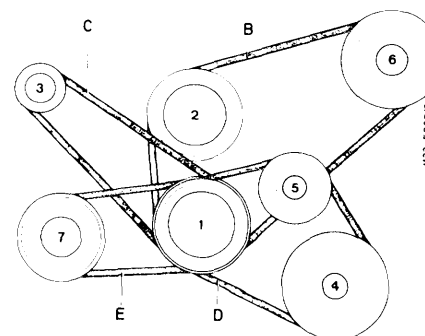

### V-belt adjusting values

V-belt width		9.5	12.5
Adjusting value KG-scale on measuring instrument	new	30	50
	used	20–25	40–45

### Special tool

Krikrit measuring instrument  
for measuring V-belt tension



001 589 69 21 00

### Note

Measuring instrument "Krikrit" is recommended for testing V-belt tension.

### Handling of measuring instrument

For checking V-belt tension, the measuring instrument can be held in different ways:

- a) With thumb and forefinger at rubber loop, with finger tips resting on pushbutton.

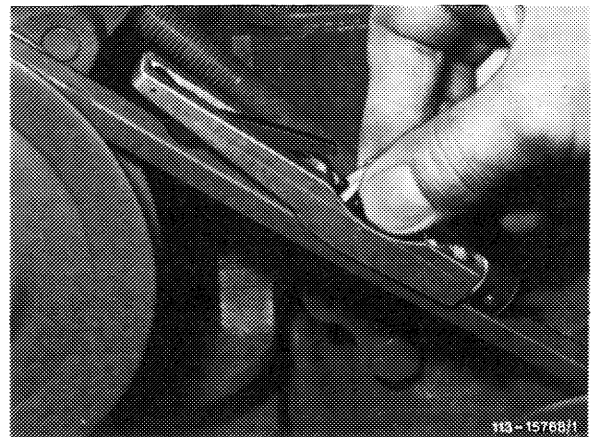

- b) With forefinger from above in rubber loop.

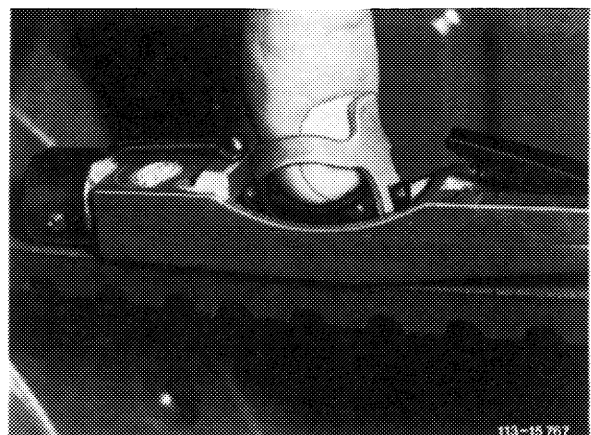

- c) With forefinger laterally between rubber loop and pushbutton.

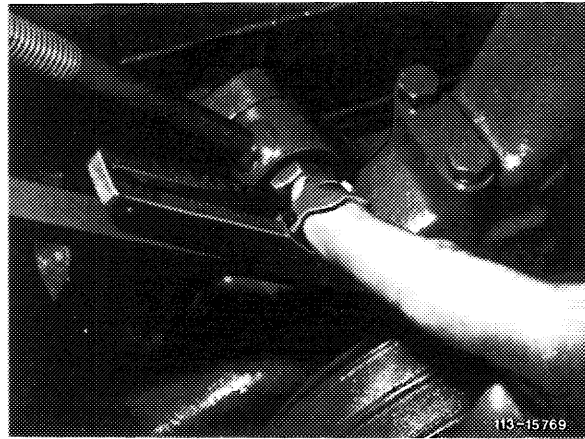

### Checkup

---

- 1 Lower indicator arm on measuring instrument.
- 2 Place measuring instrument on V-belt in center between pulleys. Lateral stop of measuring instrument should rest laterally against V-belt (arrow).

#### Attention!

On double belt drive, make sure that the measuring instrument rests on one V-belt only.

- 3 Exert a uniform, vertical pressure with pushbutton against V-belt top, until click spring audibly or noticeably disengages.

**Note:** Following disengagement of click spring, do not continue pushing measuring instrument, since otherwise a wrong measuring value will be indicated.

- 4 **Carefully** lift measuring instrument from V-belt. Avoid knocks and do not change position of indicator arm.

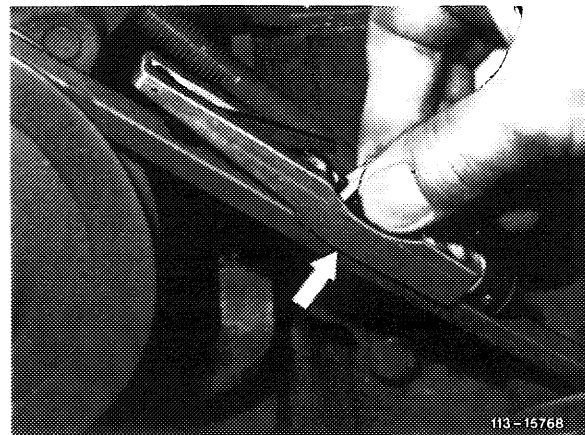

- 5 Read adjusting value on point of intersection of indicator arm and upper scale (KG-scale, arrow).

The specified adjusting values refer to KG-scale of measuring instrument.

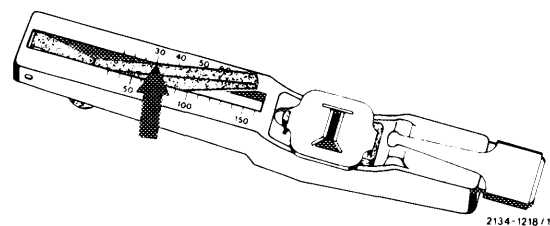

## Tensioning

---

### **V-belt A Compressor for air suspension Engine 116.981/991, 117.981**

---

- 1 Loosen nuts of the four fastening screws (1) and clamp for holding air lines.
- 2 Place a screw driver or mandrel into hole plate (2); push compressor outwards by using bolt (3) as a support and tension V-belts.
- 3 Tighten nuts of fastening screws (1) and clamp for air lines.

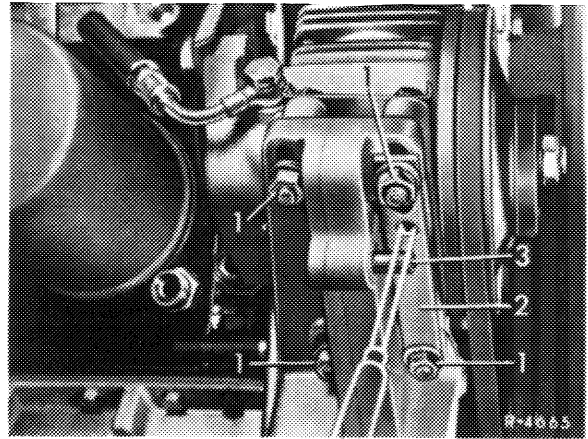

### **V-belt B coolant pump – power steering pump (with power steering pump VT 27)**

---

- 1 Loosen fastening screws (1, 2 and 4).
- 2 Loosen fastening screw (3) at swivel point only slightly.
- 3 Tension V-belt by swivelling power steering pump in outward direction.
- 4 Tighten fastening screws.

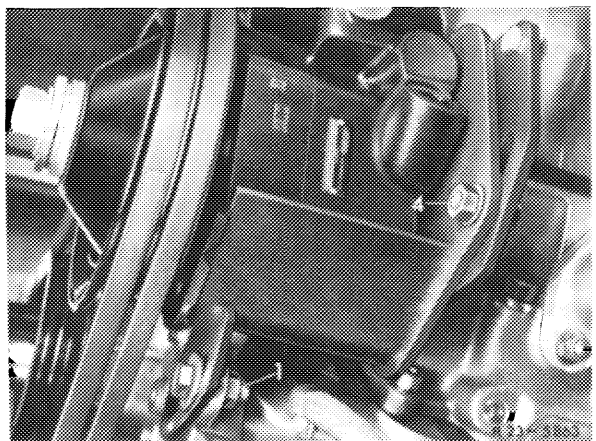
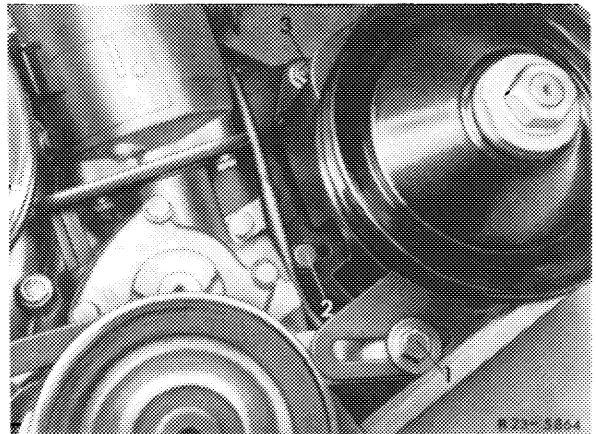

**Attention!**

If adjustments can no longer be made at fastening screw (1), move fastening screw (2) from threaded bore "a" into threaded bore "b".

When renewing V-belts, set fastening screw (2) back into bore "a".

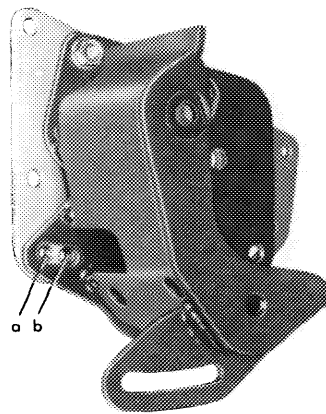

R 13/7228

**V-belt B coolant pump – power steering pump**  
(with power steering pump VT 49 or ZF)

---

- 1 Loosen fastening screws (1) and (2).
- 2 Loosen fastening screw (3) at swivel point only slightly.

Tension V-belt with toothed disc (arrow).

- 3 Tighten fastening screws (1–3).

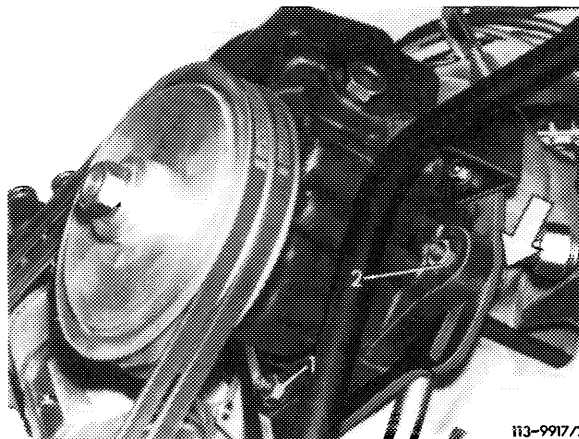

113-9917/2

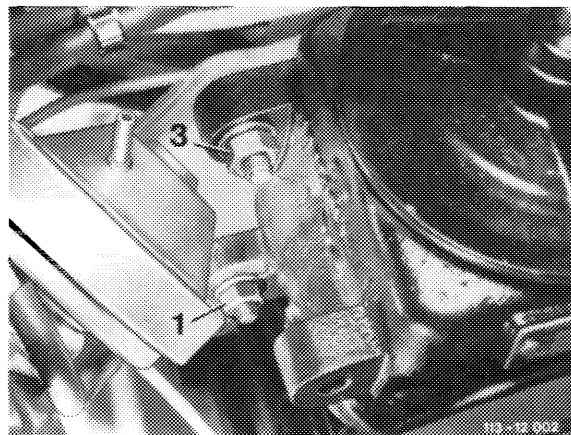

112-22 902

**V-belt C Alternator 1st version**

---

- 1 Loosen counter nut (5) and fastening screws (6 and 8).
- 2 Tension V-belt with tensioning nut (7).
- 3 Counter-lock tensioning nut and tighten fastening screws (6 and 8).

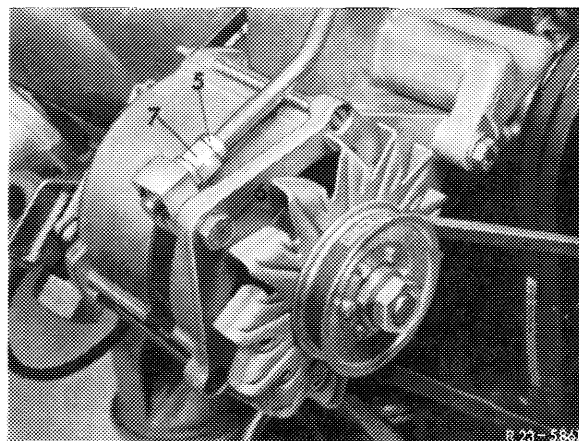

R 23 - 5861

### V-belt C Alternator 2nd version

---

- 1 Loosen fastening screw (1) and nut (2).
- 2 Tension V-belt at tensioning screw (3).
- 3 Tighten nut and fastening screw.

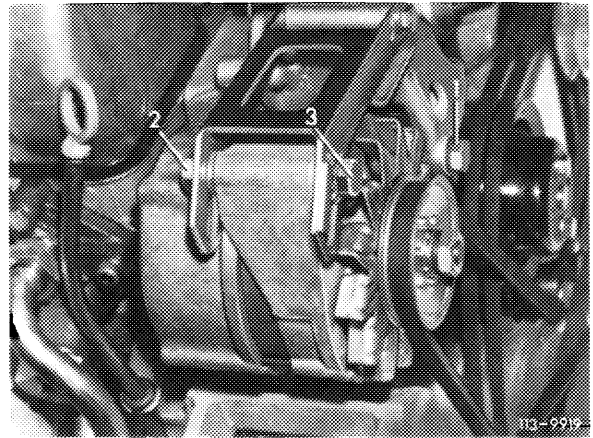

### V-belt D Refrigerant compressor

---

- 1 Loosen fastening screw (9) of tensioning roller (8).
- 2 Tension V-belt by swivelling tensioning roller.
- 3 Tighten fastening screw.

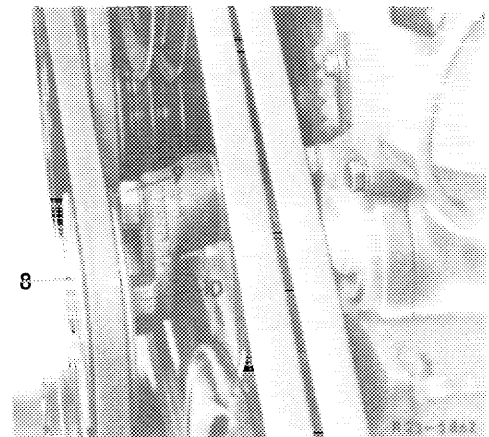

### V-belt E Air pump model year 1974

---

- 1 Loosen fastening screw (1) and (2) as well as nut of fastening screw (3) at swivel point.
- 2 Push air pump outwards until V-belt is tight.
- 3 Tighten fastening screws.

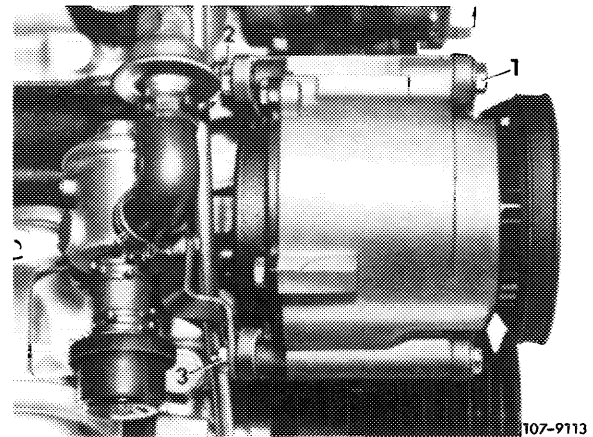

### V-belt E Air pump starting model year 1975

---

- 1 Loosen fastening screws (1, 2 and 3).
- 2 Push air pump outwards until V-belt is tight.
- 3 Tighten fastening screws.

