

## 07.3–165 Checking fuel pump relay

### Function

The fuel pump relay for voltage supply of fuel pump has two functions:

1. Activation of fuel pump while starting and with engine running.

Parallel to fuel pump, the warm-up compensator will also be activated.

2. Switching off fuel pump upon activation of fuel pump relay by safety switch.

With air flow sensor plate closed, the safety switch (2) connects ground to jack 5 (terminal 86) of fuel pump relay (1). As a result, the relay will be switched in such a manner that the fuel pump (4) can be activated only via terminal 50 (starting voltage). As soon as the air flow sensor plate is lifted, the safety switch will open and the fuel pump relay will switch over. The fuel pump is now supplied with voltage via terminal 15/54.

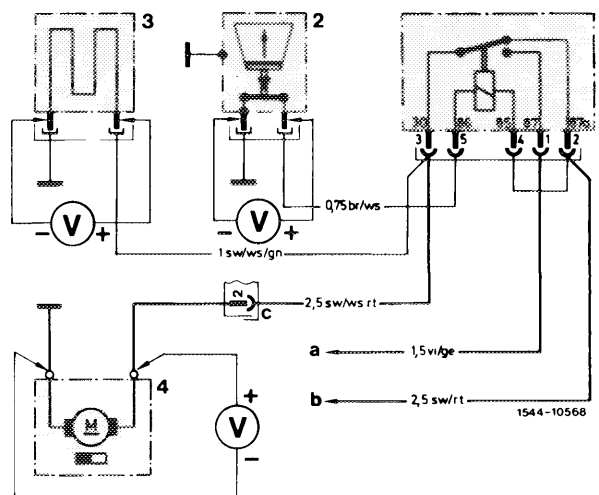
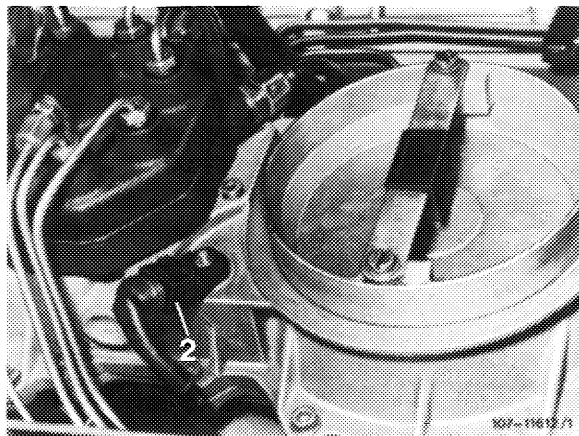

- 1 Fuel pump relay
- 2 Safety switch air flow sensor plate
- 3 Warm-up compensator
- 4 Fuel pump
- a Terminal 50 (starting)
- b Terminal 15/54 (ignition)
- c Plug connection 14-point Tail lamp harness

**Activation of fuel pump when starting and with engine running**

a) Ignition switched on.  
Fuel pump not running.

- 1 Fuel pump relay
- 2 Safety switch air flow sensor plate
- 3 Warm-up compensator
- 4 Fuel pump
- a Terminal 50 (starting)
- b Terminal 15/54 (ignition)
- c Plug connection 14-point Tail lamp harness
- Working current circuit
- - - Control circuit

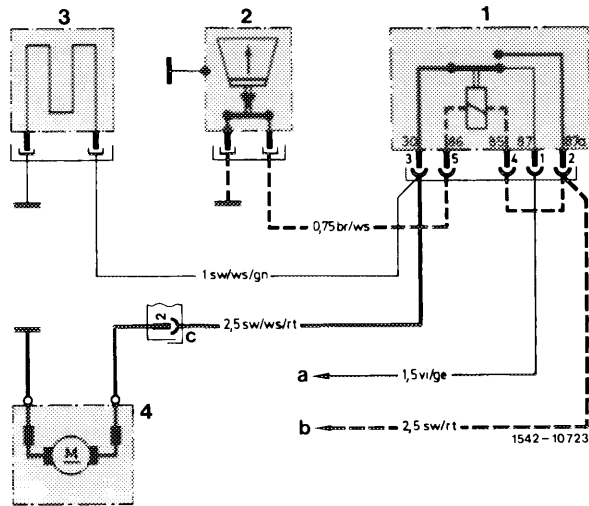

b) Starting procedure.  
Fuel pump running.

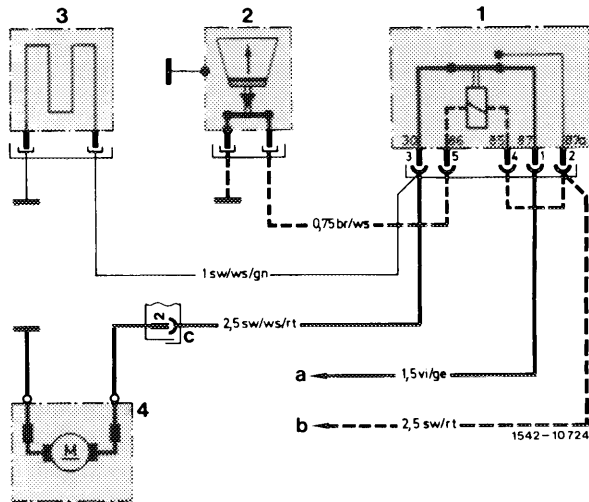

c) Engine and fuel pump running.

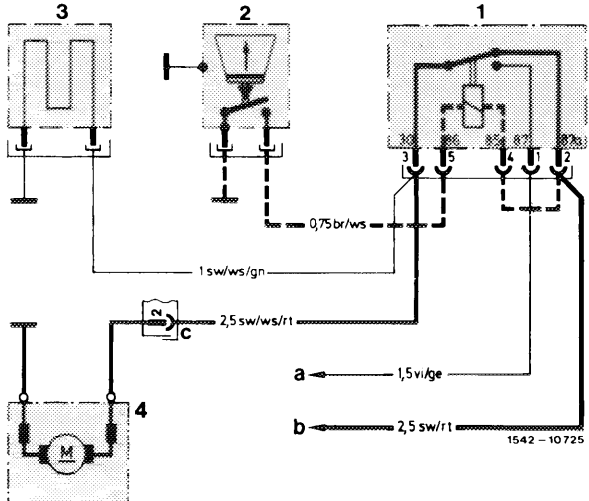

## Checking

---

### Conventional tester

---

#### Voltmeter

---

- 1 Remove air cleaner.
- 2 Switch on ignition and push air flow sensor plate for a short moment down. Fuel should audibly inject when air flow sensor plate is actuated.

If yes, the fuel pump and the safety switch are in order.

If no, check through test program.

#### Attention!

If air flow sensor plate is activated several times or for a longer period, there is the risk that too much fuel may enter combustion chamber. This may lead to a "fuel knock" during start.

Layout fuel pump relay:

Model 107: In fuse box under glove box.

The cable harness for fuel pump relay is identified with 21.

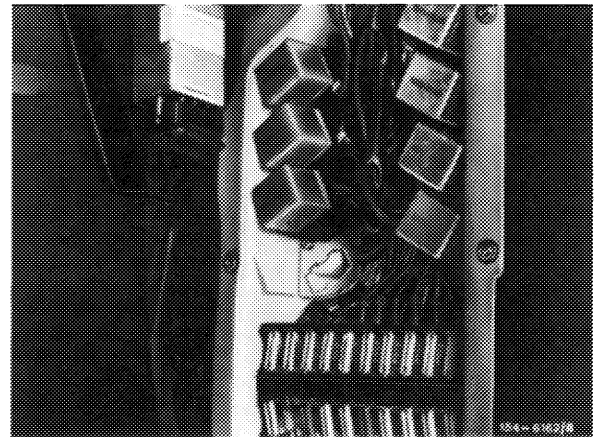

Model 116: In fuse box in lefthand wheel house.

The cable harness for fuel pump relay is identified with 21.

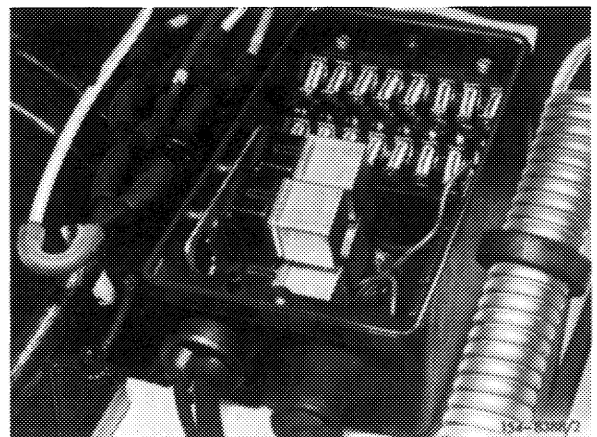

**Checking activation of fuel pump relay**

Remove fuel pump relay. Switch on ignition. Connect negative cable of voltmeter to vehicle ground. Measure voltage with positive cable of voltmeter on jack 2 (terminal 87a) and jack 4 (terminal 85) of coupler.

approx. 12 volts	0 volt
------------------	--------

Check line (terminal 15/54 black/red) for interruption.

Repair interruption.

Check zero position of air flow sensor plate. Measure voltage with voltmeter between jack 4 (terminal 85) and jack 5 (terminal 86) of coupler.

approx. 12 volts	0 volt
------------------	--------

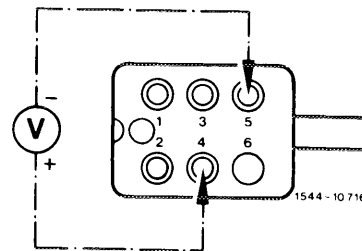
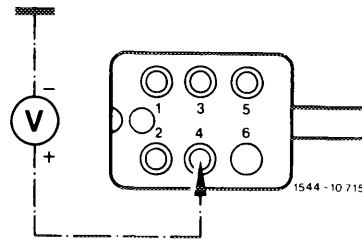
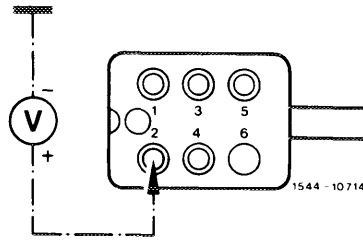
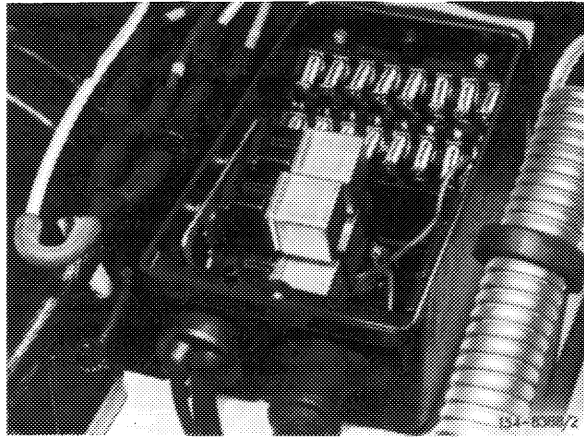

1 Test line between jack 4 and 2, as well as line brown/white to safety switch for interruption.

Repair interruption.

2 Test safety switch.

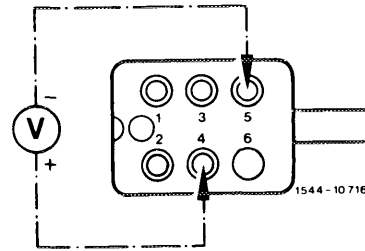
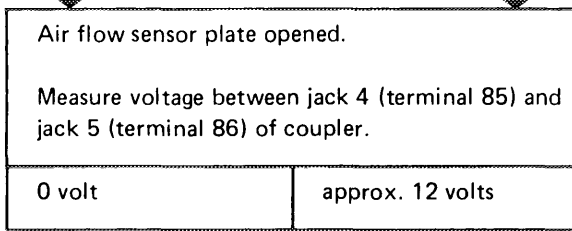

Test safety switch and renew, if required.

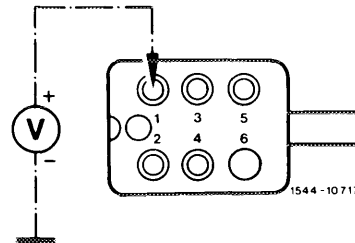
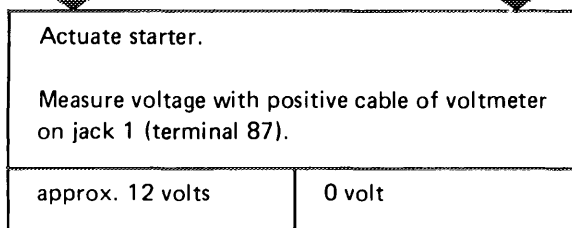

Test line purple/yellow for interruption.

Repair interruption.

### Checking activation of fuel pump

Measure voltage with voltmeter between jack 2 (terminal 87a) and jack 3 (terminal 30).

approx. 12 volts,  
fuel pump running.

0 volt

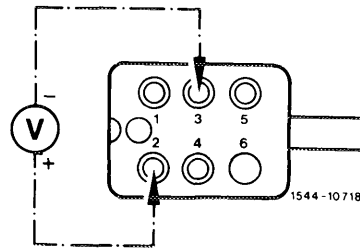

Test line black/white/red and ground connecting line for interruption (wiring diagram).

Repair interruption.

Line in order and fuel pump not running,  
renew pump.

End of test

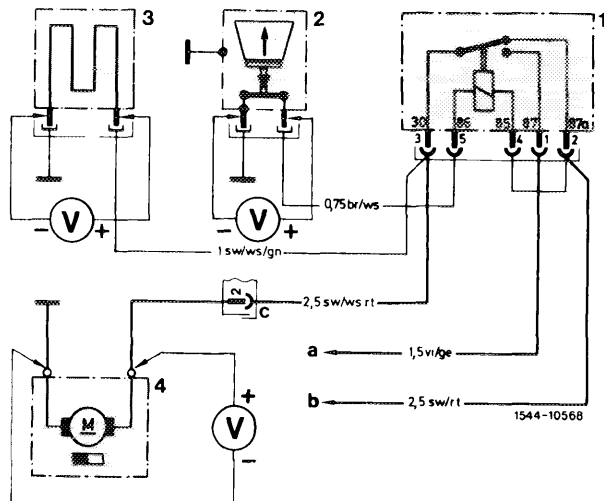

- 1 Fuel pump relay
- 2 Safety switch air flow sensor plate
- 3 Warm-up compensator
- 4 Fuel pump
- a Terminal 50 (starting)
- b Terminal 15/54 (ignition)
- c Plug connection 14-point Tail lamp harness

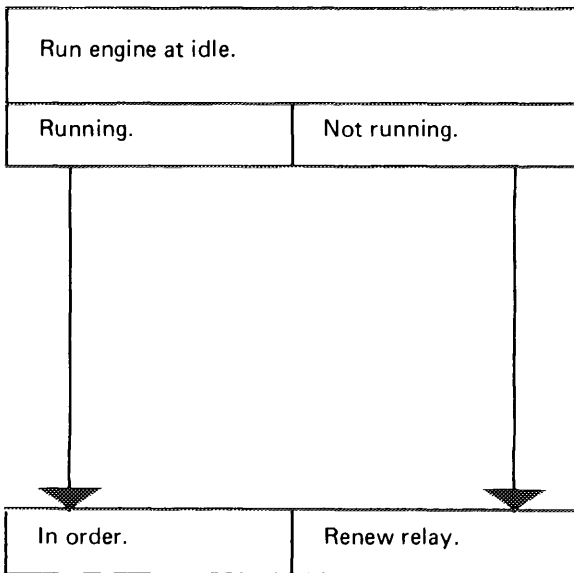

End of test.