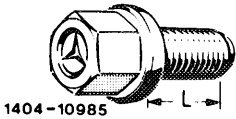
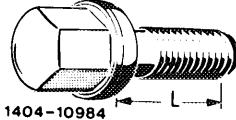

40-110 Removing and mounting of wheels

Wheel bolts for fastening wheel

Part no.	Threads	Length "L"	Type	
For steel plate and light alloy rims ¹⁾				
110 401 01 70	M 12 x 1.5	21	107 114 115 116 123 126 201	 1404-10985
For forged light alloy rim ²⁾				
108 401 00 70	M 12 x 1.5	29.5	107 114 115 116 123 126 201	 1404-10984

¹⁾ A Mercedes star is stamped into face of screw head for identification as an MB original part.

²⁾ A Mercedes star is stamped into face of threaded part for identification as an MB original part.

Centering of rims

Centering on rim dia.	Centering on front wheel hub or on rear axle shaft flange	Radial play between rim and front wheel hub or rear axle shaft flange ¹⁾
66.50 66.57	66.40 66.35	0.10 0.22

¹⁾ Checking wheel centering play.

Check centering bore of rim for burr, if any.

The wheel play between rim and front wheel hub or rear axle shaft flange should not exceed 0.2 mm. Reduce higher play by spraying quick-drying paint from a spray can against wheel center (refer to arrow), covering wheel contact surface for this purpose (refer to 40-130).

Steel plate rim

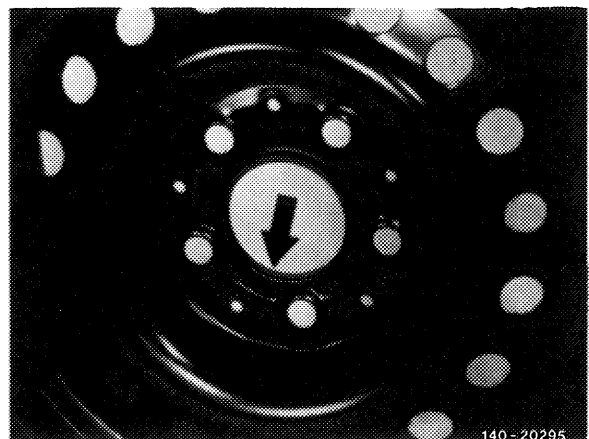

Forged light alloy rim

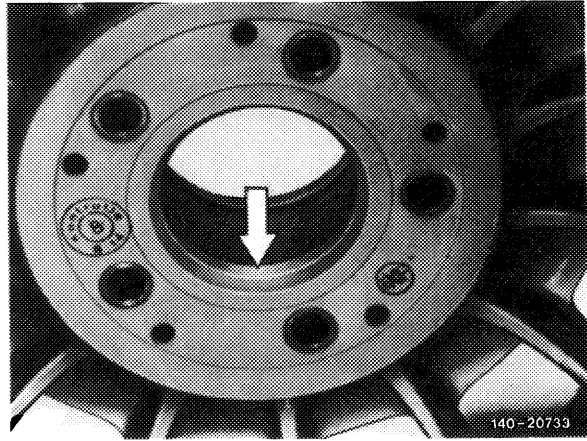

Tightening torque

Nm

Wheel bolts for fastening wheel

110

Assembly bolt for forged light alloy rim¹⁾

Model	Part no.	Threads	Length "L"	
201	201 400 00 74 ¹⁾	M 12 x 1.5	80	

¹⁾ On light alloy rims, prior to mounting wheel, screw assembly bolt available with spare wheel into screw hole located at the top.
²⁾ Spare parts scope of delivery includes: Assembly bolt and rubber sleeve (rubber sleeve serves for fastening bolt in spare wheel).

Conventional tools

Electric or pneumatic impact wrench with limited tightening torque of 100 Nm	e.g. Atlas-Copco D-7250 Leonberg order no. LMS 26 HR 01
Hex. socket for impact wrench, OD max. 26.5 mm	e.g. Hazet D-5630 Remscheid order no. 900 S
Torque wrench, automatically releasing	e.g. Rahsol D-5650 Solingen order no. 7562-1

Wheel attachment

Never mix up spherical collar bolts for steel plate and light alloy rims with spherical collar bolts for forged light alloy rims.

Check spherical collar bolts. Clean dirty bolts. Replace screws with damaged threads, worn zinc layer on spherical collar and with corroded spherical collar. Check threads in front wheel hub and rear axle shaft flange for easy operation and refinish, if required.

There should be no dirt or grease on spherical collar of bolts as well as on spherical segments of rims, since otherwise the threads of the spherical collar bolts and of front wheel hub or rear axle shaft flange will be excessively strained.

Contact surfaces on rim and front wheel hub or on brake disk bowl must be clean. Clean corroded surfaces with wire brush or emery cloth.

Always tighten spherical collar bolts with torque wrench on principle.

Check torque wrench regularly.

Re-tighten new rims after a mileage between 100 and 500 km. The reason for this requirement is the setting of the spherical sections for wheel fastening.

Steel plate and light alloy rim

Forged light alloy rim

Wheel attachment
front axle

- 1 Rim
- 2 Brake disk
- 3 Front wheel hub
- 4 Spherical collar bol

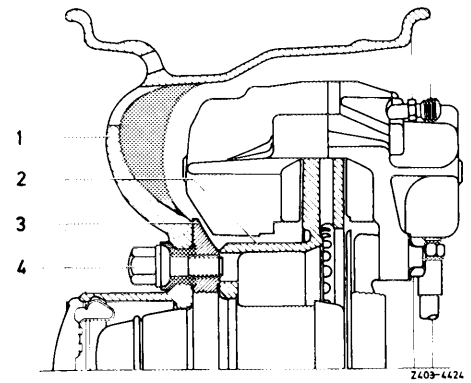
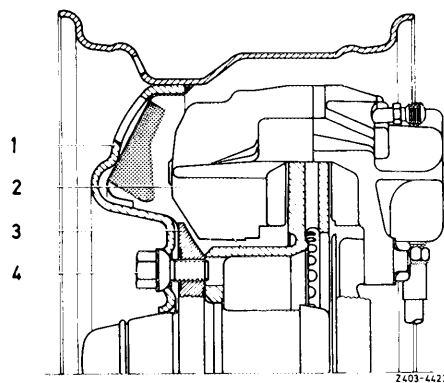

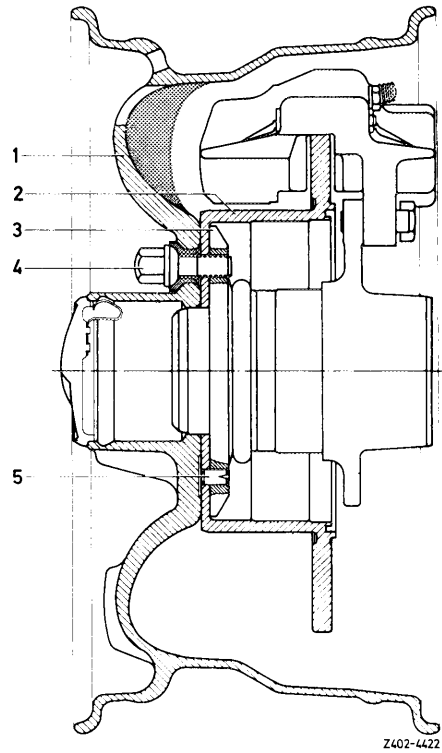
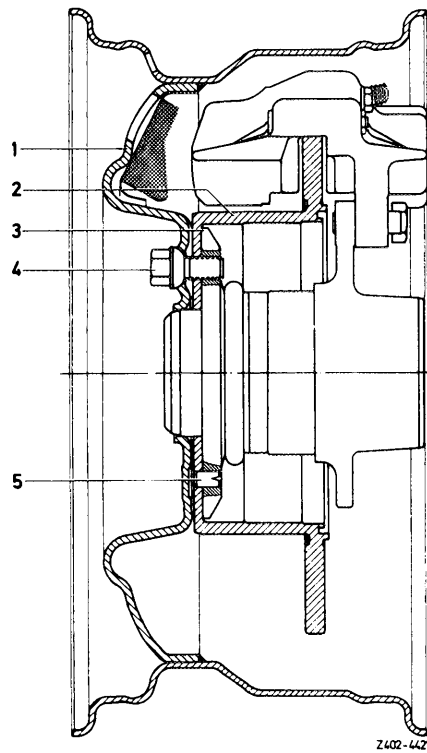

**Wheel attachment
rear axle**

- 1 Rim
- 2 Brake disk
- 3 Rear axle shaft flange
- 4 Spherical collar bolt
- 5 Fitted pin for locating
brake disk

Note

On model 201 with forged light alloy rims use assembly bolt available with spare wheel for mounting wheel.

- 1 Spare wheel
- 039 Assembly bolt
- 039a Rubber sleeve

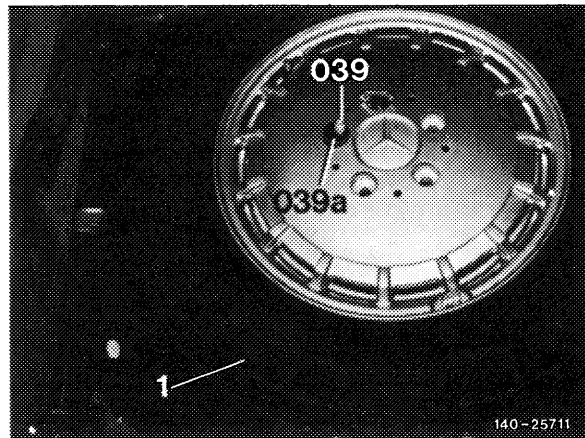

Prior to mounting wheel, screw assembly bolt into tapped hole located at top (arrow).

- 039 Assembly bolt

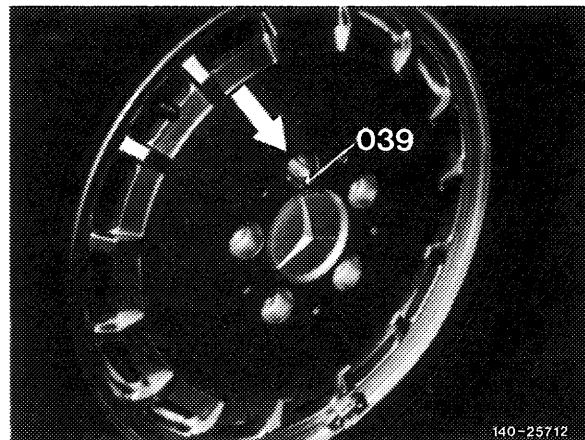

Make sure that the wheels are not distorted by one-sided tightening of spherical collar bolts.

Tighten spherical collar bolts crosswise in several steps.

Make particularly sure that the first wheel bolt is not already tightened to its full tightening torque prior to at least screwing-on the others.

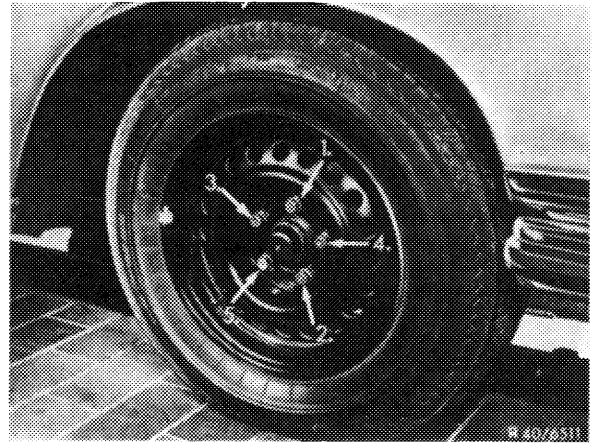

When using impact wrenches, tighten only up to appr. 3/4 of the required torque, then tighten with torque wrench while not exceeding specified value.

Experience has shown that impact wrenches will already obtain a tightening torque of 60 to 70 Nm under a single impact. When impacts continue, some impact wrenches may already have established an essentially excessive tightening torque, which may lead to a deformation of rim, damage to threads or fracture of spherical collar bolts.

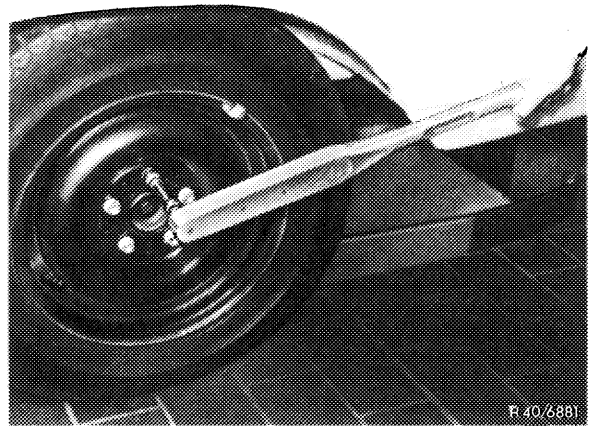

On forged light alloy rims, the OD of the wheel wrench or socket wrench element for impact wrench may amount to max. 26.5 mm, since otherwise hub of wheel may be damaged. When unscrewing last spherical collar bolt, make sure that the wheel is not tilting, since otherwise the paint on wheel hub may suffer damage.

For tightening spherical collar bolts, use a torque wrench with automatic release (click wrench).

Ventilated rims are subject to a high air flow. Prior to mounting rim, check wheel disk for contamination and clean, if required.

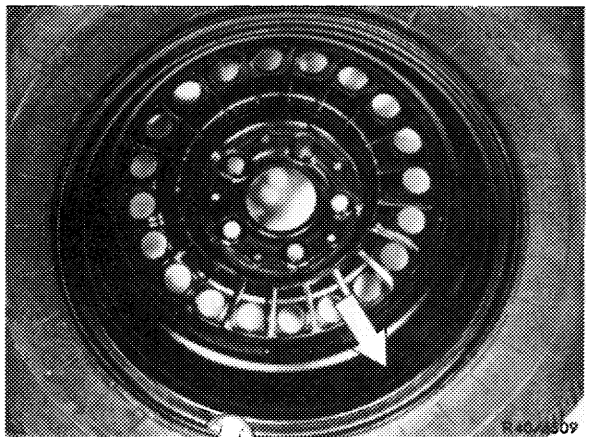

Steel plate rim

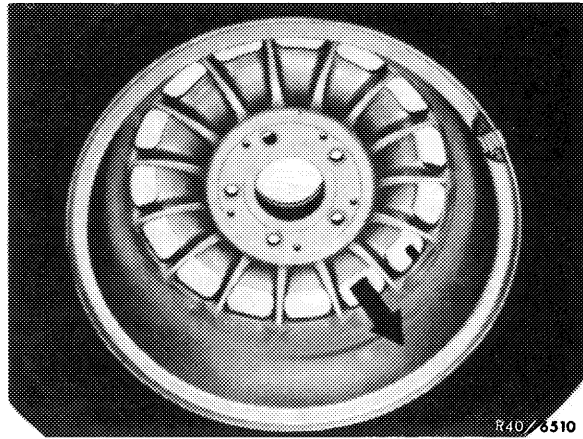

Forged
light alloy rim