

INTRODUCTION

This manual contains schematic diagrams, component location descriptions and photographs for the cars shown in Table 1 below. The manual consists of six sections: one section for each of the 5 car groups and one section that contains Automatic Climate Control data for all cars.

The first page of each section is an index page. Circuits are listed alphabetically with page numbers for schematics and component location descriptions. Schematic diagrams should be referred to when diagnosing a problem (see Troubleshooting Procedure, page 7). The component location descriptions and photographs are used to locate components on the vehicle.

Automatic Climate Control data, for all cars for which it's applicable, is contained in the last section of the book. Refer to the ACC index on page 301 for the listing of ACC data by car sales designations.

1982 SALES DESIGNATIONS	MODEL
240 D	123.123
300 D (TURBO).....	123.133
300 CD (TURBO)...	123.153
300 TD (TURBO)...	123.193
300 SD (TURBO)...	126.120
380 SL	107.045
380 SEL	126.033
380 SEC	126.043

TABLE 1

HOW TO USE THIS MANUAL

How to Read Schematic Diagrams

Electrical components which work together are shown together. Schematic drawings are arranged so that current flows from positive at the top of the page, to negative at the bottom. Fuses are shown at the top of the page. All wires, connectors, switches and motors are shown in the flow of current to ground at the bottom of the page. The "hot" labels appearing at the top of fuses or components show the IGNITION SWITCH positions which supply power to that point.

The terminal number "30" appearing on the IGNITION SWITCH and LIGHT SWITCH means that these terminals are always supplied with power. The terminal number "15" on the IGNITION SWITCH means that this terminal is supplied with power only when the IGNITION SWITCH is in the "Run" or "Start" positions.

Component and Wire Representation

All wiring between components is shown exactly as it exists on the vehicle. Wiring inside complicated components has been simplified to aid in understanding their electrical operation. Transistorized components are shown as plain boxes labeled "solid state." Switches and sensors are shown "at rest," as if the IGNITION SWITCH were off. Notes are included which describe how switches and other components work.

Circuits Which Share Power and/or Grounds

Each circuit is shown completely and independently on one schematic diagram. Other circuits which get their power from the same point, or which ground at the same point as the circuit you are looking at, are not shown. However, if other circuits actually share a wire or wires within the schematic diagram, they are partially represented.

Power Distribution and Ground Distribution Diagrams

The Power Distribution diagrams show connections from the BATTERY and ALTERNATOR to the fuses, and to the IGNITION SWITCH and LIGHT SWITCH. This will tell you how each circuit gets its power, and what circuits share common fuses. Ground Distribution diagrams show how several circuits are connected to common grounds.

Component Identification

Component names are found underlined next to or above each component. The name is followed, in many cases, by some detail about the component or its operation. Below the component name, in parentheses, you may find a "code" number. This is the factory harness marking number. It is printed on tape wrapped around the branch of the wiring harness which feeds that component.

Some Automatic Climate Control components have a number with an asterisk above the component name. This is the ACC training number for that component.

SYMBOLS

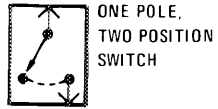

ONE POLE,
TWO POSITION
SWITCH

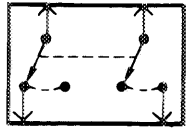

SWITCHES THAT
MOVE TOGETHER
DASHED LINE SHOWS
A MECHANICAL
CONNECTION
BETWEEN SWITCHES

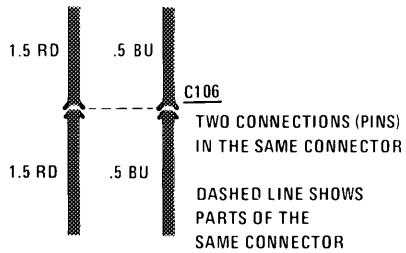

TWO CONNECTIONS (PINS)
IN THE SAME CONNECTOR
DASHED LINE SHOWS
PARTS OF THE
SAME CONNECTOR

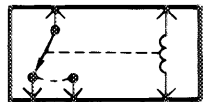

RELAY SHOWN WHEN COIL IS
ENERGIZED, SWITCH
IS PULLED CLOSED
WITH NO
CURRENT
FLOWING
THROUGH
COIL

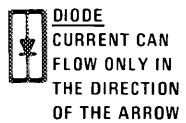

DIODE
CURRENT CAN
FLOW ONLY IN
THE DIRECTION
OF THE ARROW

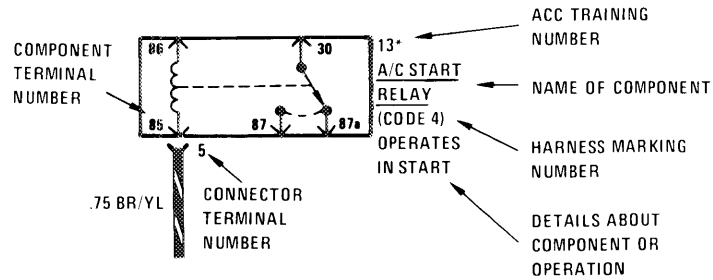

ACC TRAINING
NUMBER
NAME OF COMPONENT
HARNESS MARKING
NUMBER
DETAILS ABOUT
COMPONENT OR
OPERATION

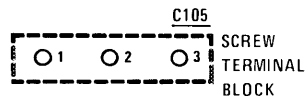

TWO PARTS
OF THE
SAME
COMPONENT

WIRE INSULATION	
COLOR	ABBREVIATIONS
BLACK	BK
BROWN	BR
RED	RD
YELLOW	YL
GREEN	GN
BLUE	BU
VIOLET	VI
GRAY	GY
WHITE	WT
PINK	PK

WIRE SIZE CONVERSION CHART	
METRIC (CROSSSECTIONAL AREA IN MM ²)	AWG (AMERICAN WIRE GAUGE)
.5	20
.75	18
1	16
1.5	14
2	14
2.5	12
4	10
6	8
8	8
16	4
20	4
25	2
32	2

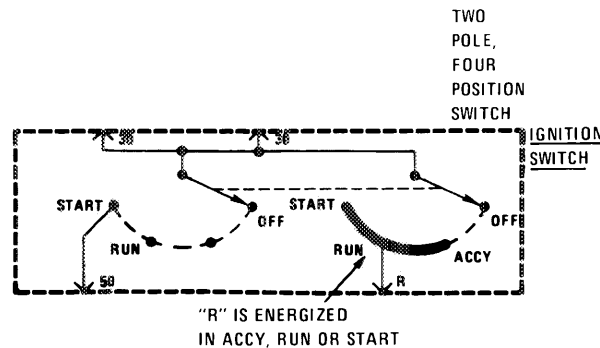

"R" IS ENERGIZED
IN ACCY, RUN OR START

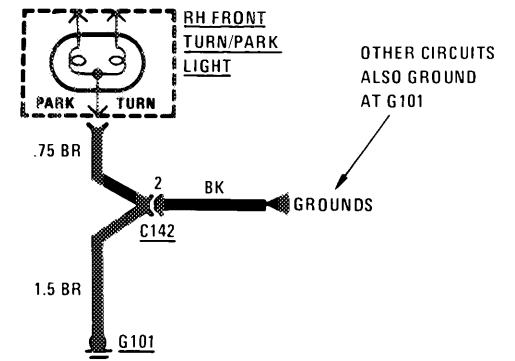



ENTIRE COMPONENT SHOWN



PART OF A COMPONENT SHOWN

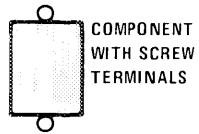

COMPONENT WITH SCREW TERMINALS



SOLID STATE TRANSISTORIZED COMPONENT

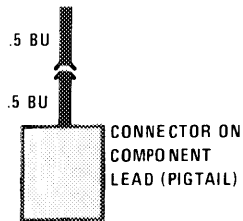

CONNECTOR ON COMPONENT LEAD (PIGTAIL)

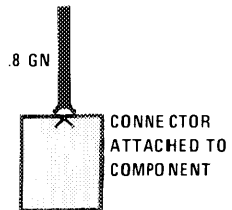

CONNECTOR ATTACHED TO COMPONENT

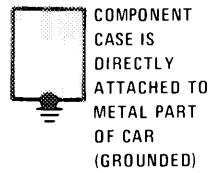

COMPONENT CASE IS DIRECTLY ATTACHED TO METAL PART OF CAR (GROUNDED)

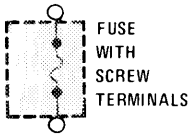

FUSE WITH SCREW TERMINALS

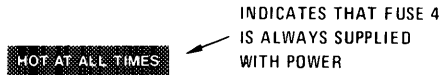

INDICATES THAT FUSE 4 IS ALWAYS SUPPLIED WITH POWER

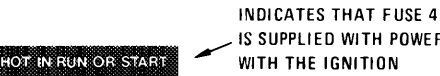
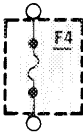

INDICATES THAT FUSE 4 IS SUPPLIED WITH POWER WITH THE IGNITION SWITCH IN THE RUN OR START POSITIONS

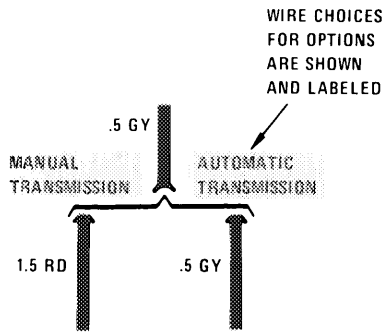
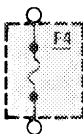

WIRE CHOICES FOR OPTIONS ARE SHOWN AND LABELED

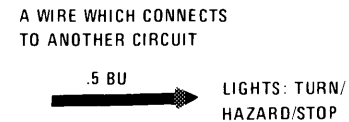
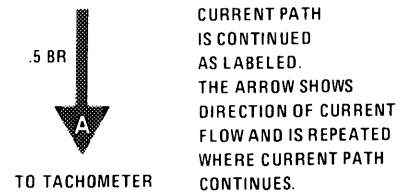
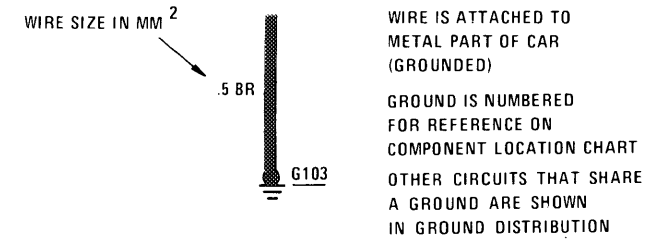
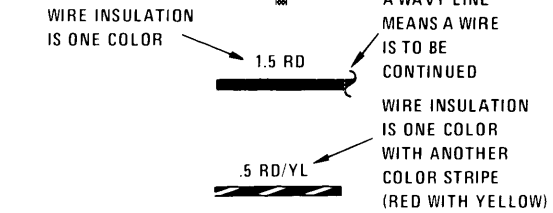
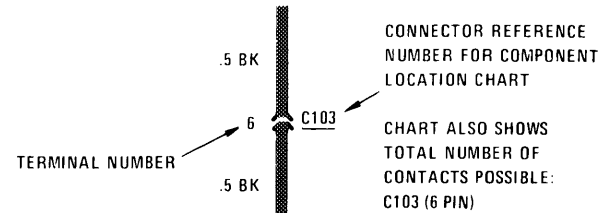

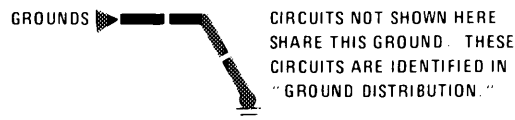
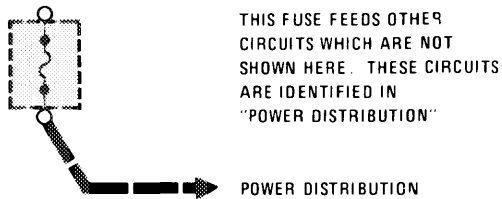

VACUUM RESTRICTORS ARE POROUS BRASS PLUGS IN THE VACUUM HOSE. THE RESTRICTOR SLOWS THE VACUUM FLOW.



VACUUM CAN FLOW EASILY IN THE DIRECTION OF THE ARROW. VACUUM CANNOT FLOW AGAINST THE ARROW.

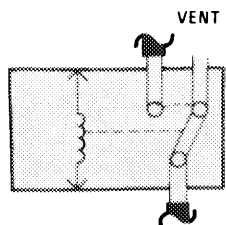

NO VACUUM

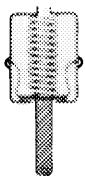

VACUUM ELEMENTS PUSH OR PULL A SHAFT BETWEEN TWO FIXED POSITIONS. WHEN VACUUM IS APPLIED, THE SHAFT IS PULLED IN. WHEN NO VACUUM IS PRESENT, THE SHAFT IS PUSHED OUT BY A SPRING.

TROUBLESHOOTING PROCEDURE

1. VERIFY THE COMPLAINT

Operate the problem circuit in all modes to check the accuracy of the complaint. This may give a clue as to the extent, nature, and location of the problem.

2. CHECK THE FUSE AND RELATED CIRCUITS

Determine the extent of the problem by operating circuits which share the same fuse. If the other circuits work, the fuse is good. The cause must be within the wiring unique to the problem circuit.

3. REFER TO THE E.T.M. AND ANALYZE THE CIRCUIT

Study the circuit schematic to learn how the circuit should operate. The schematic will tell you:

- Where the circuit receives current
- What circuit protection is involved
- What switches control current flow
- How the loads operate

Understanding the total circuit is necessary if you are to troubleshoot efficiently. Determine possible problem areas and testing locations. The Component Location table tells where components and ground points are located.

4. SYSTEMATICALLY TEST THE CIRCUIT IN ORDER TO ISOLATE THE PROBLEM

As a general guideline:

- If the fault affects a single component of a circuit, start to test at that component.
- If the fault affects a number of components of a circuit, start to test at the point where the circuit gets its power.

5. MAKE THE REPAIR

After you have narrowed the problem down to a specific cause, repair as necessary.

6. VERIFY CIRCUIT OPERATION

First operate the repaired circuit in all modes to be sure you have fixed the entire problem. Next, operate all circuits which share the same fuse. Be sure that this does not cause the problem to reappear.

TESTING TOOLS

A **VOLTMETER** is used to measure voltage at various points within a circuit. If an analog **VOLTMETER** is used, it must have a resistance of at least 20,000 ohms per volt in the low range. Any digital **VOLTMETER** may be used.

Use of an **OHMMETER** should be limited to harness wiring, connections and switches. It should not be used on solid state components or relays. An **OHMMETER** measures a circuit for its resistance to current flow. Since an **OHMMETER** has an internal battery that provides current to the circuit under test, it is first necessary to disconnect the car battery. This will ensure that there is no voltage already present in the circuit.

An **ACC Adaptor Switch** is used to test circuits in the new Automatic Climate Control system. To use this tester, first unplug the connector from the **ELECTRONIC UNIT FOR TEMPERATURE CONTROL**. Then plug this connector to the Adaptor Switch (M-B part no. 126 589 03 21 00). A voltmeter-ohmmeter is then connected to the Adaptor Switch.

TESTS

Voltage Drop Test

This test checks for voltage being lost along a wire, or through a connection or switch. Connect the positive lead of the **VOLTMETER** to the end of the wire, or to the side of the connection which is closest to the battery. Connect the negative lead to the other end of the wire, or the other side of the connection. When the circuit is operated, the **VOLTMETER** will show the difference in voltage between the two points. A difference (or drop) of more than one volt indicates a problem.

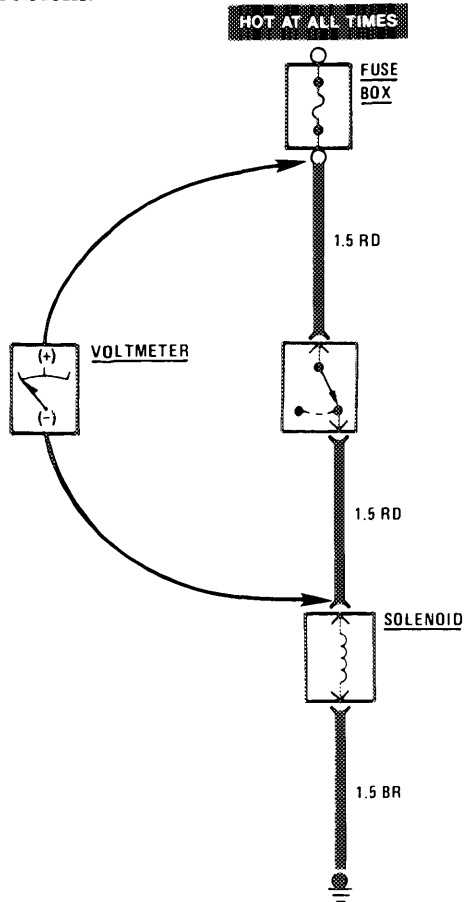

Voltage Drop Test

Testing For Short to Ground With a Voltmeter

1. Remove the blown fuse and disconnect the load.
2. Connect the **VOLTMETER** across the fuse terminals.
3. Beginning near the fuse box, move the harness from side to side while watching the **VOLTMETER**.
4. If the meter registers, there is a short to ground in the wiring.

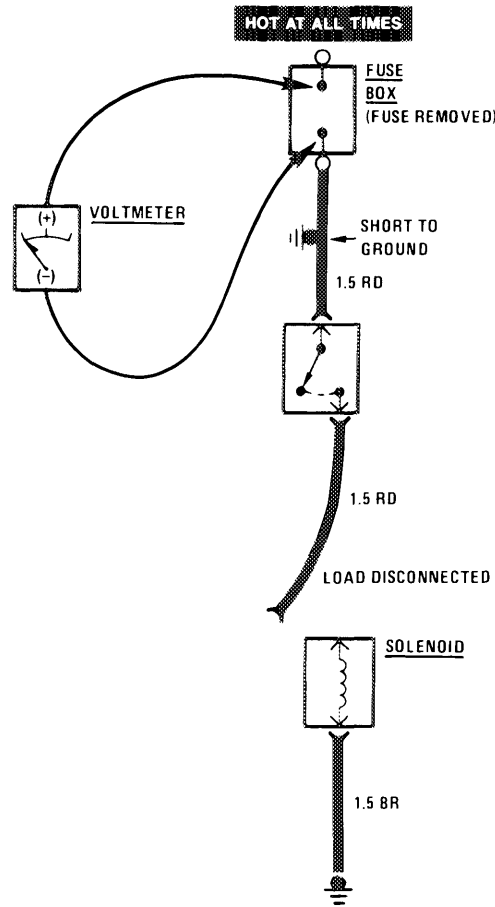

Testing for Short with Voltmeter

Testing For Short to Ground With an Ohmmeter

1. Calibrate **OHMMETER** by adjusting the needle to zero while holding the leads together.
2. Remove the blown fuse and disconnect the battery and load.
3. Connect one lead of the **OHMMETER** to the fuse terminal on the load side.
4. Connect the other lead to a known good ground.
5. Beginning near the fuse box, move the harness from side to side, while watching the **OHMMETER**.
6. If there is no short, the meter will show infinitely high resistance. If the meter registers low or no resistance, there is a short to ground in the wiring.

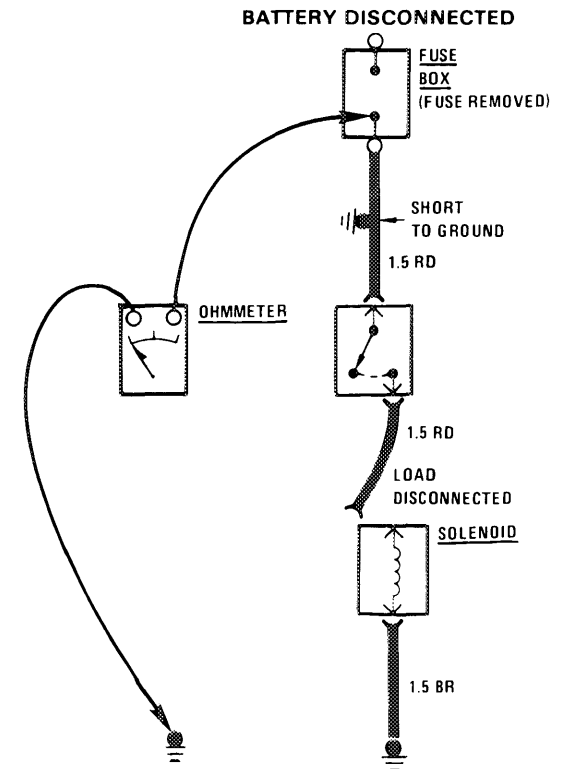

Testing for Short with Ohmmeter

Continuity Test

1. Check OHMMETER by adjusting the needle to zero while holding the leads together.
2. Disconnect the car battery.
3. Connect one lead of the OHMMETER to one end of the part of the circuit you wish to test.
4. Connect the other lead to the other end.
5. If the meter shows low or no resistance, there is continuity.

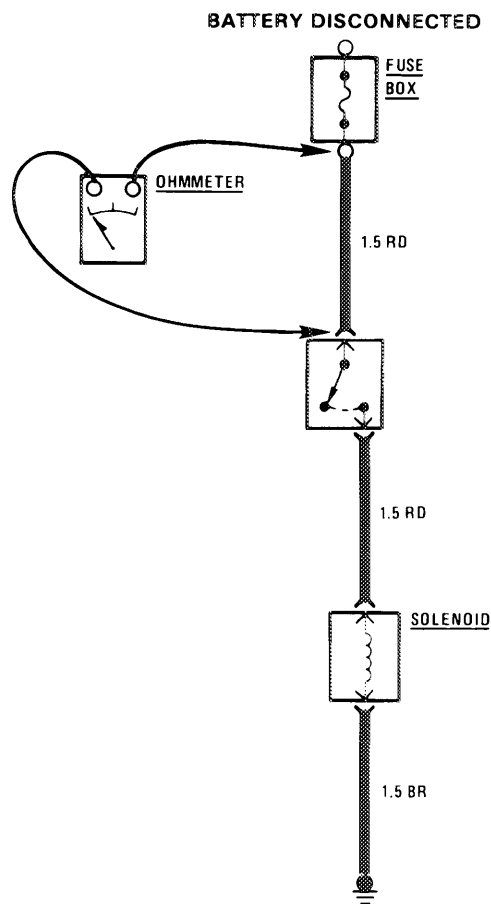

Continuity Test

Voltage Test

1. Connect the negative lead of the VOLTMETER to a known good ground or negative (-) battery terminal.
2. Connect the positive lead of the VOLTMETER to a point (connector or terminal) you wish to test.
3. If the meter registers, there is voltage present. This voltage should be within one volt of measured battery voltage. A loss of more than one volt indicates a problem. A loose connection is a likely cause. Take readings at several points along the circuit to isolate the problem.

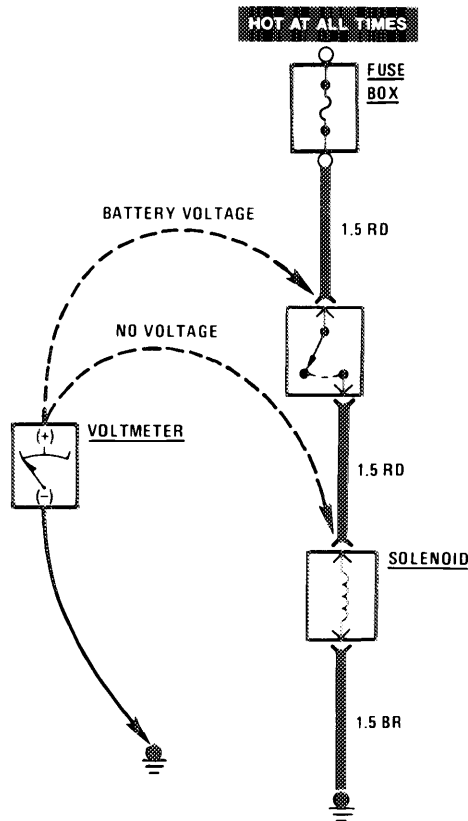

Testing Vacuum Components

A VACUUM TESTER is used to apply vacuum to vacuum components. The tester (M-B part no. 589 25 2100) registers in mbar of vacuum. Two Typical applications of this tester are shown below.

PERMISSIBLE LEAKS	
Check Valves	50 mbar in 10 min. at 300 mbar vacuum
Other Vacuum Components	20 mbar/min. at 300 mbar vacuum

