

## Check values

Distance "c" of front bearings	Model 107.02, 114, 115	1125 ± 2 mm
	Model 107.04	920 ± 2 mm
	Model 116	1314 ± 2 mm
	Model 123, 126	1290 ± 2 mm
Deviation on outer bearing brackets for connection to semi-trailing arms <sup>1)</sup>	Camber misalignment (STA)	0 to 1.0 mm
	Track misalignment (SPA)	0 to 0.5 mm <sup>2)</sup>

1) Measuring by means of light gap between plug pin of control mount and bore in bearing bracket of rear axle carrier. All-around uniform light gap in bore = 0 mm misalignment. Close fit of plug pin in bore = 1 mm misalignment.

2) On model 123 the control mounts are designed for the second version of the rear axle carrier (identification: additional bore in right-hand inner bearing bracket for connection to semi-trailing arm). When checking a rear axle carrier of the first version, note that the plug pin in minus track direction rests against edge of bore already at a deviation of approx. 0.5 mm, and in plus camber direction already at a deviation of approx. 0.2 mm.

On model 107 the control mounts are designed for the 1st version of the rear axle carrier (without identification). When checking a rear axle carrier of the 2nd version (identification: On model 107.02 an additional bore in righthand inner bearing bracket for swivelling semi-trailing arm, while on model 107.04 both resilient stops are provided with a recess on outer side). When checking a rear axle carrier of the 2nd version, note that here the plug pin in minus track direction should rest against edge of bore already at a deviation of approx. 0.5 mm, and in plus camber direction already at a deviation of approx. 0.2 mm.

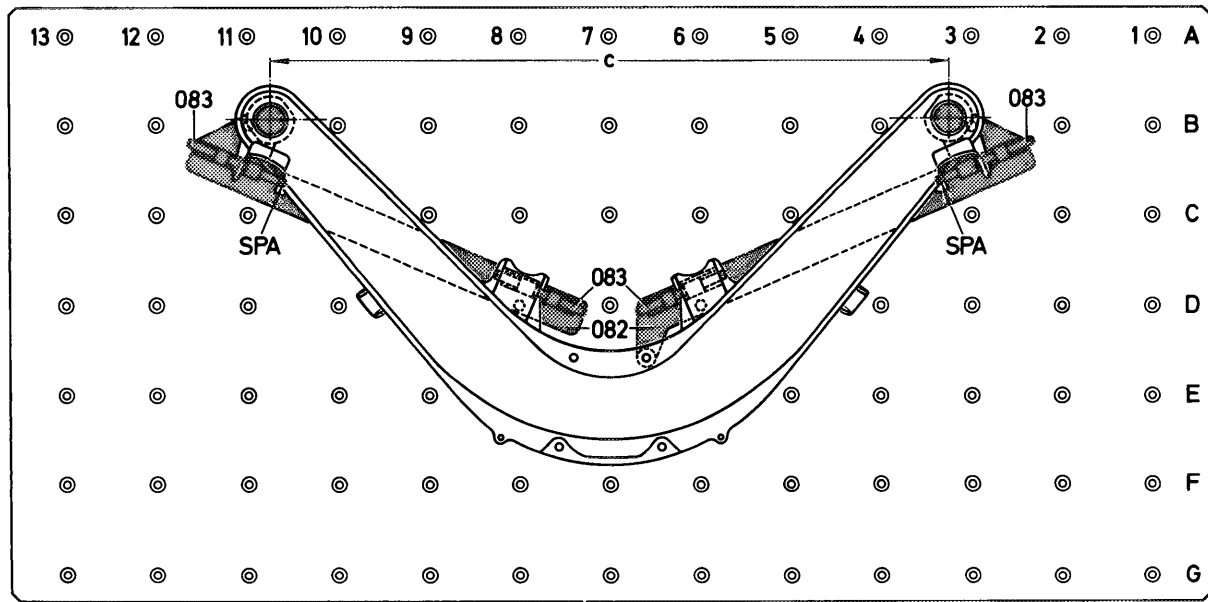
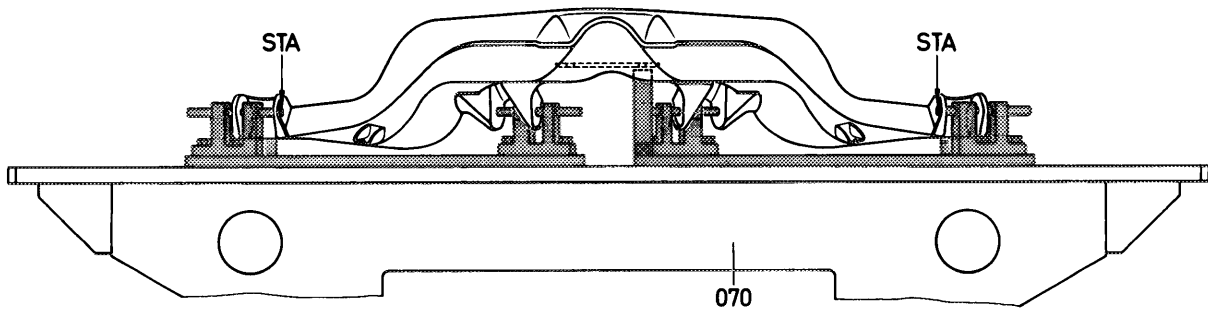

1350-7016

- c Distance of front bearings (reference dimension)
- STA Measuring points for camber misalignment on outer bearing brackets for connection to semi-trailing arms
- SPA Measuring points for track misalignment on outer bearing brackets for connection to semi-trailing arms
- 070 Measuring table
- 082 Control mounts
- 083 Plug pins

## Required equipment

Measuring table with coordinate  
bore holes 13 mm dia F7,  
spacings 150 mm

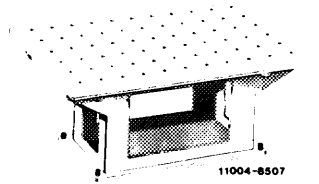

BE 03600 1522  
E 0145

## Special tools

Plug pin for control mounts  
(required 4 each)



116 589 16 15 00

Model 107.02, 114, 115  
Control mounts for rear axle carrier

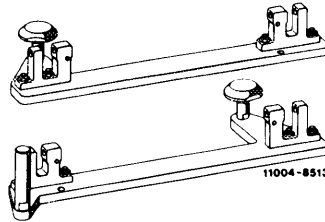

115 589 32 23 00

Model 107.04  
Control mounts for rear axle carrier

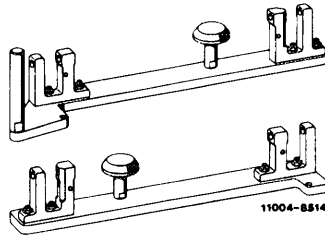

107 589 07 23 00

Model 116  
Control mounts for rear axle carrier

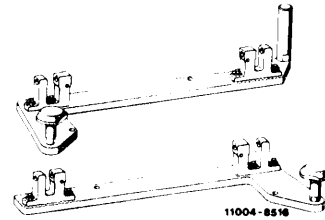

116 589 14 23 00

Model 123  
Control mounts for rear axle carrier

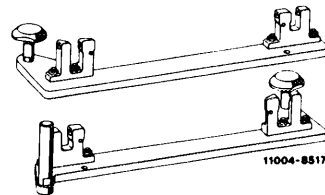

123 589 03 23 00

Model 126  
Control mounts for rear axle carrier

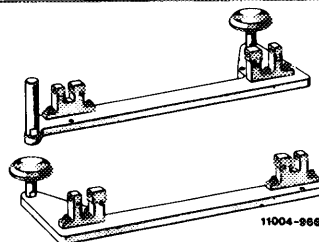

126 589 00 23 00

Fitted screw with wing nut for  
locating control mounts  
(required 4 each)

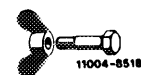

116 589 19 63 00

## Note

For measuring the directional stability system and its various components a measuring table of 2000 x 1000 mm will be required. The measuring table has coordinate bore holes of 13 mm dia F7 spaced 150 mm apart for locating the control mounts. The coordinate bore holes are identified in longitudinal direction with the numbers 1 to 13 and in transverse direction with the letters A to G.

The control mounts for the individual rear axle carriers are different and are marked in relation to respective model.

Model 107.02, 114, 115  
Model 107.04  
Model 116  
Model 123  
Model 126

The checkup itself is the same for all rear axle carriers.

The rubber mounts of the front rear axle carrier bearings must be removed for checkup.

The measuring values before and following axle reconditioning must be recorded in "Data sheet for directional stability of rear axle" (35-410).

Checkup of rear axle carrier comprises:

- a) Distance of front bearings
- b) Contact surfaces of front bearings
- c) Location of outer bearing brackets in relation to semi-trailing arm connection in direction of camber and track with inner bearing brackets in fixed position

On rear axle carrier for model 123, starting April 1977, on model 107.022, starting September 1980, and on model 107.042, starting March 1980, a change has been made on bearing brackets for connection of semi-trailing arms. Compared with the 1st version, the camber to the complete direction of stability system has been changed in minus direction by approx.  $0^{\circ} 15'$  and the toe-in in plus direction by approx. 1.0 mm per wheel. (Also refer to section 35-410 Complete inspection of rear axle directional stability).

**On model 123, the control mounts are designed for 2nd version, and on model 107 for 1st version of the rear axle carrier.**

Identification (starting January 1978 or starting September 1980) for rear axle carrier of 2nd version:

Additional bore of 10 mm dia. on righthand, inner bearing bracket for connection of semi-trailing arm (arrow).

When checking rear axle carrier 1st version on model 123 and on model 107.02 2nd version, note the following:

In plus camber direction the plug pin rests already against edge of bore at a deviation of approx. 0.2 mm.

In minus track direction the plug pin rests against edge of bore at a deviation of approx. 0.5 mm.

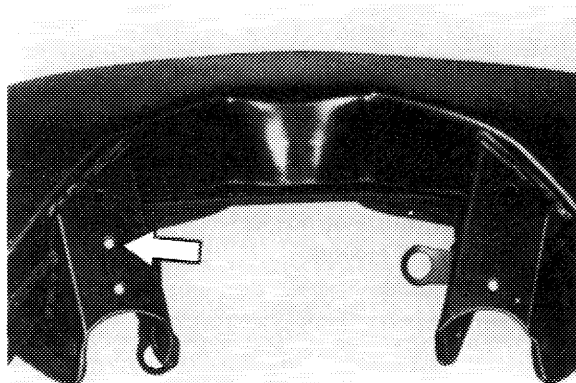

Model 107,02 and 123

135-14120

Identification characteristic (starting March 1980) for rear axle carrier of 2nd version:

Additional recess on both resilient stops on outer sides for model 107.04 (arrow).

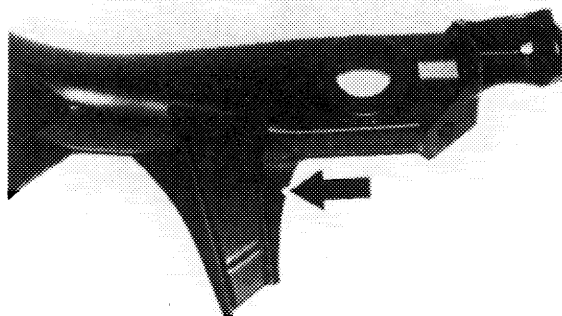

Model 107.04

135 - 20125

When checking rear axle carrier 2nd version, note the following:

In plus camber direction, at a deviation of approx. 0.2 mm, the plug pin rests already against edge of bore.

In minus track direction, at a deviation of approx. 0.5 mm, the plug pin rests already against edge of bore.

### Checkup

1 Attach both control mounts on measuring table with fitted screws and wing nuts, while making sure that the coordinate bore holes are always in agreement.

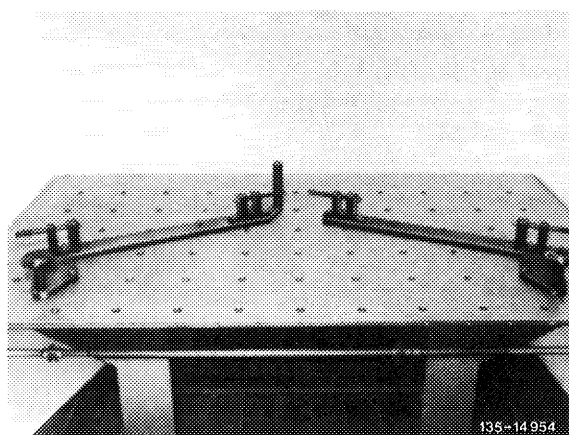

135 - 14 954

### Associated coordinate bore holes for control mounts

Model	Right-hand		Left-hand	
	inner	outer	inner	outer
107.02 114, 115	D6	B3	D8	B11
107.04	D6	B3	B8	B11
116	D5	B3	D9	B11
123, 126	D6	B3	D8	B11

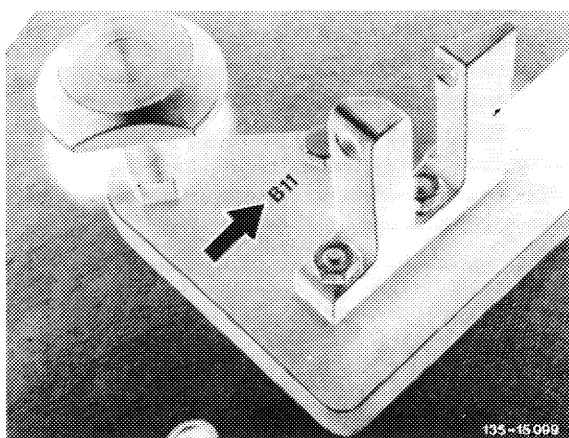

135 - 15 099

2 Check position of mounting bracket for front bearings of rear axle carrier in relation to base plate of control mount left and right. In correct position the two punched in check points (arrow) are properly aligned.

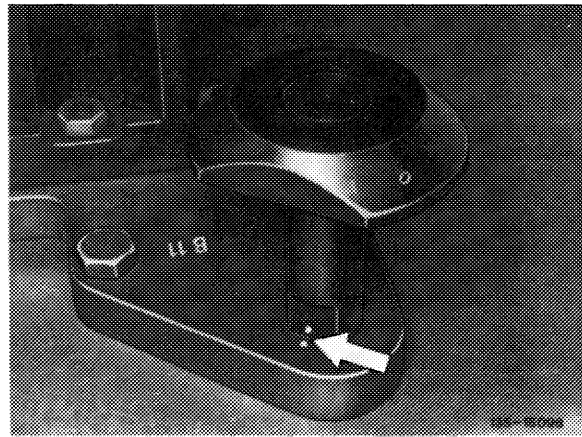

3 Place rear axle carrier on control mounts. If rear axle carrier cannot be introduced or only when applying force against the two cups of the front bearings, measure distance "c" of front bearing with precision measuring tape. Suitably place precision measuring tape on one side against inner edge of bore and on other side against outer edge.

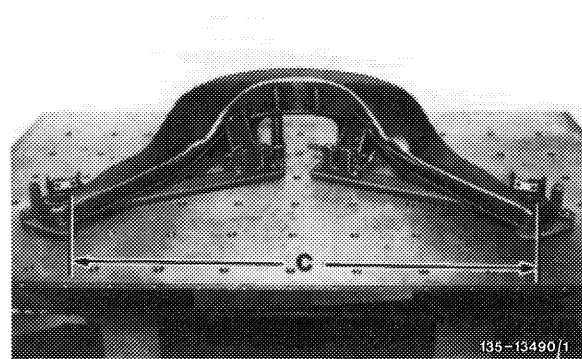

**Distance "c" of front bearings**

Model 107.02, 114, 115	1125 ± 2 mm
Model 107.04	920 ± 2 mm
Model 116	1314 ± 2 mm
Model 123, 126	1290 ± 2 mm

4 Slightly lift rear axle carrier in center and insert a slip gauge 1 mm thick (082b) at mounting pin. Insert plug pins (083) at both bearing brackets of inner bearings of semi-trailing arms. If the plug pins cannot be inserted at inner bearing with the slip gauge inserted and pulled out (tolerance range), the rear axle carrier is so far beyond permissible tolerance that no other test will be required.

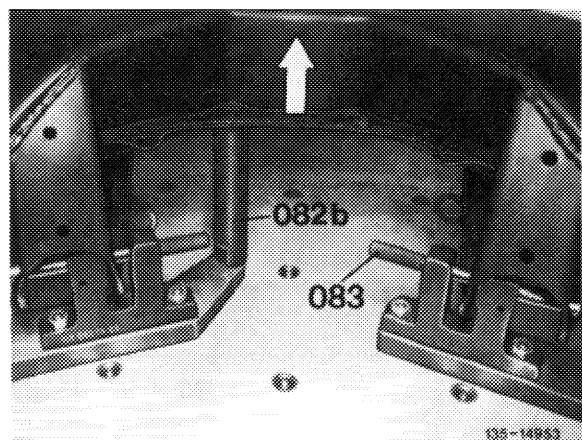

5 To check front bearings of rear axle carrier, check difference in height of contact surfaces for control mount left and right with a slip gauge.

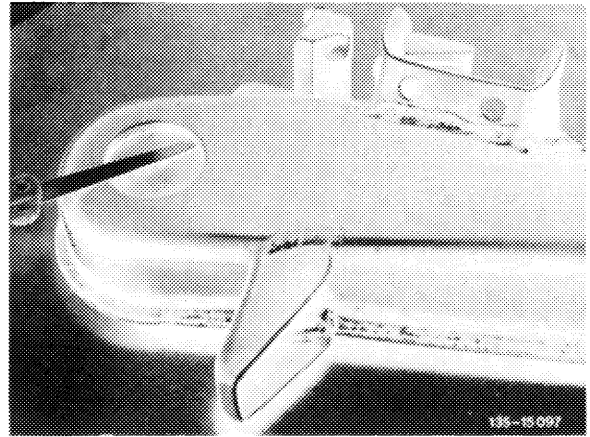

6 Check position of outer bearing brackets in relation to semi-trailing arm connection in direction of camber and track, slip-in both plug pins (083) and measure light gap in bore of bearing brackets.

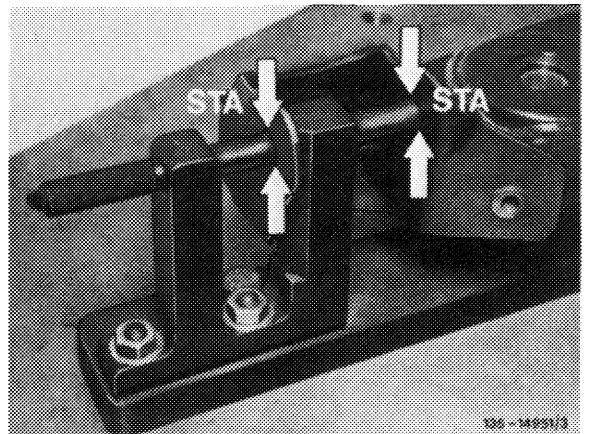

Checkup in camber direction

Uniform light gap = deviation 0 mm  
Well fitting pin = deviation 1 mm

STA = camber misalignment in plus and minus direction

SPA = track deviation in plus and minus direction

**Check values**

Chamber deviation (STA)	0 to 1.0 mm
-------------------------	-------------

Track deviation (SPA)	0 to 0.5 mm
-----------------------	-------------

Checkup in track direction

