

32-120 Checking of shock absorber

Test values for shock absorbers

Designation	Part no.	Color code (on housing for front shock absorber, on lower suspension eye for rear shock absorber)	Adjustment in N at 100/min and 50 mm stroke for new or exchange shock absorbers		Check of oil reserve in shock absorber	
			Extension	Compression	Piston rod exposure „a“ Adjustments for new shock absorbers mm	Max. perm. values mm

Front shock absorbers

Gas pressure shock absorbers with separating piston¹⁾
Bilstein, Boge and F & S⁴⁾

Bilstein ⁵⁾	123 323 17 00	1 lengthwise line white	980	480	0 + 2	32
	123 323 18 00	2 lengthwise lines white	1100	630		
Boge ⁵⁾	123 323 25 00	1 slanted line white	1060	430		
F & S ⁵⁾	123 323 27 00	1 crosswise line white	980	480		
	123 323 28 00	2 crosswise lines white	1100	630		

Gas pressure shock absorbers without separating piston²⁾
F & S

F & S	123 323 20 00	1 crosswise line white	1080	490	20 ± 2	0
	123 323 23 00 ³⁾	2 crosswise lines white	100	630		

¹⁾ If the max. length of exposed piston rod is exceeded, the shock absorber loses its effectiveness.

²⁾ If the max. length of exposed piston rod is not met, the shock absorber loses its effectiveness.

³⁾ 2nd version with cylinder pipe longer by 9 mm (starting June 1978); 1st version (up to May 1981) was 123 323 21 00.

⁴⁾ Shock absorber with separate supplementary rubber spring length 84 mm.

⁵⁾ Shock absorbers of different makes are carried in stock according to type of spring under one part no. as scope of delivery.

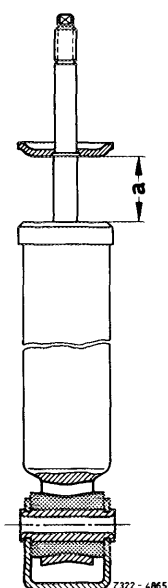

Front shock absorbers
a Piston rod-exposed length

with separating piston

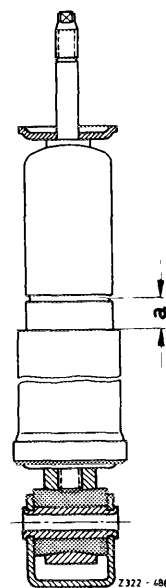

without separating piston

Designation	Part no.	Color code (on housing for front shock absorber, on lower suspension eye for rear shock absorber)	Adjustment in N at 100/min and 50 mm stroke for new or exchange shock absorbers		Check of oil reserve in shock absorber	
			Extension	Compression	Piston rod exposure „a” Adjustments for new shock absorbers mm	Max. perm. values mm

Rear shock absorber

Gas pressure shock absorbers **with** separating piston¹⁾
Bilstein, Boge and F & S

Designation	Part no.	Color code	Adjustment in N at 100/min and 50 mm stroke		Piston rod exposure „a”	Max. perm. values
			Extension	Compression		
Bilstein ⁵⁾	123 326 06 00	1 lengthwise line white	1800	1050	0 + 2	32
	123 326 07 00	2 lengthwise lines white	2330	1170		
Boge ⁵⁾	123 326 18 00	1 slanted line white	1800	1050		
F & S ⁵⁾	123 326 16 00	1 crosswise line white	1800	1050		
	123 326 17 00	2 crosswise lines white	2330	1170		

Gas pressure shock absorbers **without** separating piston²⁾
F & S and Boge

Designation	Part no.	Color code	Adjustment in N at 100/min and 50 mm stroke		Piston rod exposure „a”	Max. perm. values
			Extension	Compression		
F & S	123 326 10 00	1 crosswise line white	1780	1050	105 ± 2	82
	123 326 11 00	2 crosswise lines white	2470	1250		
Boge	123 326 15 00	1 slanted line white	1760	1070	147 ± 2	137

¹⁾ If the max. length of exposed piston rod is exceeded, the shock absorber loses its effectiveness.

²⁾ If the max. length of exposed piston rod is not met, the shock absorber loses its effectiveness.

⁵⁾ Shock absorbers of different makes are carried in stock according to type of spring under one part no. as scope of delivery.

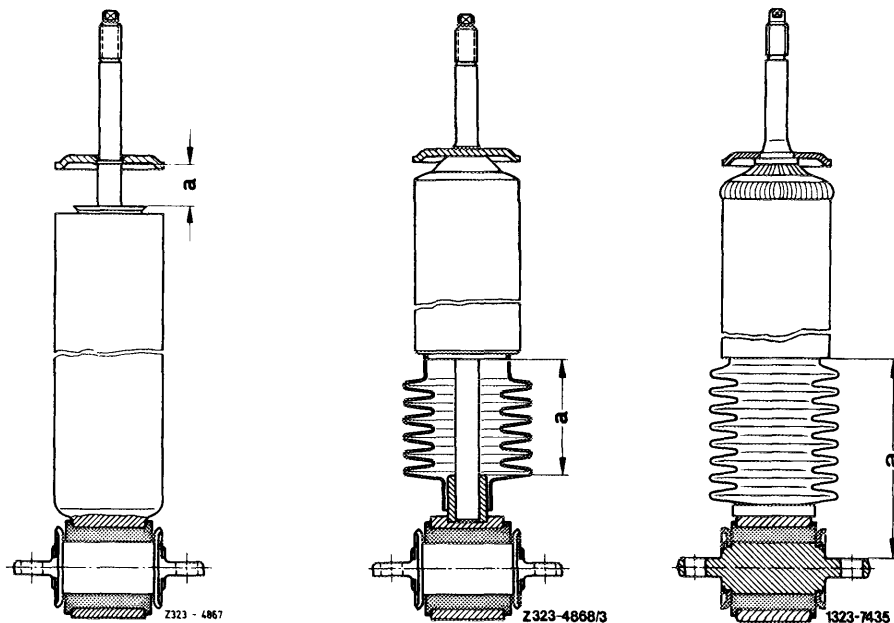

Rear shock absorber
a Piston rod exposed length

with separating piston

without separating piston

without separating piston

Notes

When testing and evaluating gas pressure shock absorbers a fundamental difference must be made between two designs. The difference refers to the separation of the oil and gas chamber.

Gas pressure shock absorbers with separating piston between oil and gas chamber (Bilstein, Boge and F & S). **Installation position of shock absorber with piston rod in upward direction.**

Gas pressure shock absorber without separating piston between oil and gas chamber (F & S and Boge). **Installation position of shock absorber with piston rod in downward direction.**

- 1 Cylinder
- 2 Operating piston with spring washers
- 3 Piston rod
- 4 Closing package with piston rod seal and piston rod guide
- 5 Separating piston
- 6 Baffle plate
- a Oil chamber
- b Gas chamber

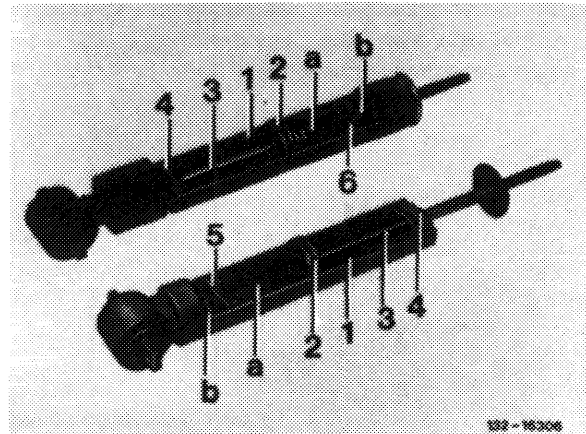

Oil reserve in shock absorber

The oil reserve in shock absorber is determined by means of exposed piston rod length "a". While measuring the oil reserve, the temperature of the shock absorber should amount to approx. 20 °C. In the event of an oil loss, the exposed length of piston rod on shock absorbers with separating piston will be increased. On shock absorbers without separating piston it will be decreased. After exceeding or falling below permissible exposed length, replace shock absorber, since it will loose in effectiveness.

Shock absorbers with separating piston

Push piston rod up to stop of operating piston on separating piston.

Measure exposed length "a".

a Length of exposed piston rod

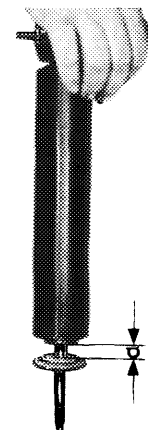

R-3743

Shock absorbers without separating piston

Compress shock absorbers — with piston rod in upward direction — until a clearly noticeable, additional resistance is felt, that is, until piston encounters oil column.

Measure exposed length "a".

Front shock absorber
F & S

a Length of exposed piston rod

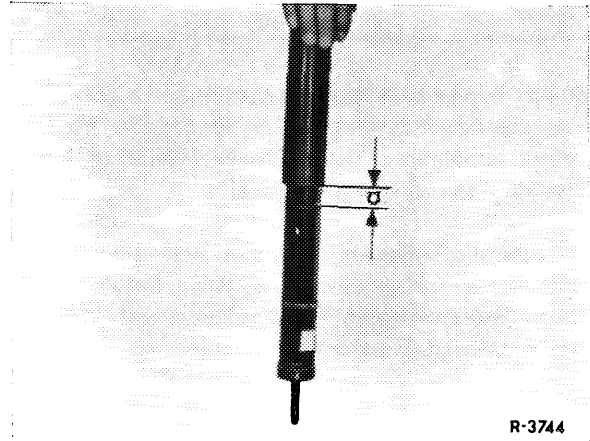

Note: When checking oil reserve on shock absorbers without separating piston, any occurring hissing noises are without significance.

Rear shock absorber
F & S

a Length of exposed piston rod

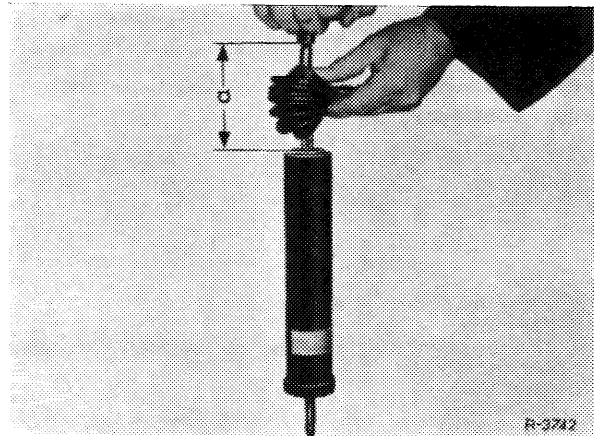

Rear shock absorber
Boge

a Length of exposed piston rod

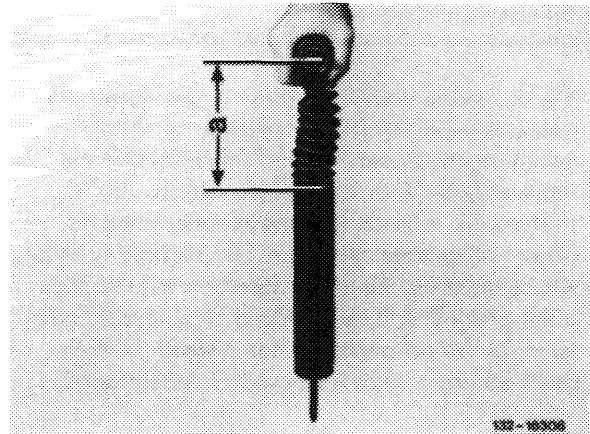

Sight test

Check piston rod carefully for surface damage.

Check piston rod for bends. A bent piston rod is recognized by binding when inserted into guide bushing.

Note: For lubricating guide bushing outside piston rod seal, the piston rod is designed to provide a slight oil film.

The alignment of the suspension points is important for the correct function of the piston rod seal. In the event of leaks on piston rod seal, be sure to check whether alignment of suspension points is in order.

Rumbling and knocking noises

Check upper suspension for correct assembly, lower suspension for tight seat of fastening bracket and rubber mount in housing eye.

On front shock absorbers made by F & S, rumbling noises may occur, which are caused when a fastening bracket is too loose. To check, move fastening bracket manually. Bracket should be hard to move.

Measure oil reserve.

In the event of very high oil losses, shock absorbers with separating piston are showing a tendency toward knocking, since the piston rod may knock against separating piston during deflection. On rear shock absorbers, check alignment of upper suspension point on frame floor in relation to lower suspension point on semitrailing arm (32–126).

A loose operating piston may be responsible for the knocking.

To check, push piston rod inwards in installation position of shock absorber, release and push-in again. If the operating piston is loose, a change between pushing and pulling will be noticed by a knocking noise.

Hissing noises

In the event of a leaking piston, shock absorbers with separating piston are showing a tendency toward hissing noises, since gas will enter the oil system and foaming will occur. Such shock absorbers may very well be still operational, but should nevertheless be replaced.

Attention!

Shock absorbers without separating piston, in which the oil and the gas chamber are not absolutely separated, the noise etc. can be checked in installation position, that is, with the piston rod downwards. If, prior to checking for noise, the oil reserve has been checked (with the piston rod upwards) or if the shock absorber has been stored with the piston rod in upward direction or in horizontal position, the oil has been mixed up with gas. Noises can be evaluated only after pushing the piston rod several times inwards.

Scrapping of shock absorbers

When scrapping shock absorbers, pay attention to pertinent safety rules.

To discharge the pressure, carefully drill into shock absorber tube with a 5 mm drill until the gas flows out.

To prevent accidents caused by the escaping gas, as well as as a protection against drilling chips during these jobs, be sure to wear goggles and gloves. Drill hole with as little feed as possible.

Scope of work

Clamp shock absorber into a vise with piston rod vertically in downward direction. Drill into shock absorber tube, approx. 20 mm from shock absorber bottom, with a 5 mm drill (black arrows).

On shock absorbers with separating piston, push piston rod down up to stop and pull out. Then drill a second hole (gray arrows) approx. 60 mm from shock absorber bottom. The oil can now flow out.

Oil capacity depending on version 250–500 cm³.

Note: Do not drill second hole, which is 60 mm from bottom, first. If shock absorbers are drilled in horizontal position, the oil escaping under pressure will be heavily sprayed around.

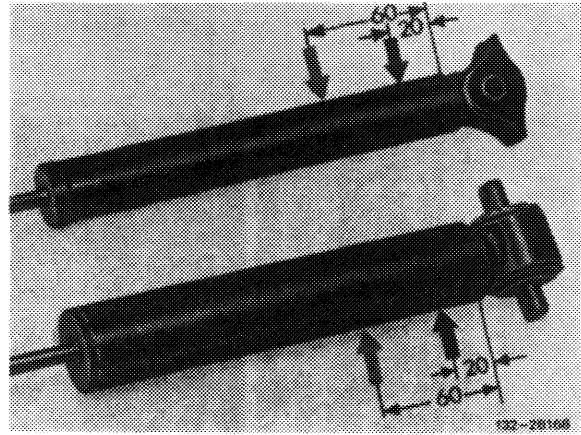

On shock absorbers **without** separating piston, pump out oil after drilling by operating piston several times.

Oil capacity depending on version 250–500 cm³.

